

CHAT BOARD

products
2024 - 2025



introduction

The original and first of its kind, the CHAT BOARD® magnetic glass board saw the light of day in 2003 as the joint invention of glass specialist Hans Henning Jensen and his hotelier daughter, Josefine Honoré.

The deceptively simple product was conceived from a wish to elevate the conventional noticeboard to a higher aesthetic level, and to encourage and strengthen visual communication. Not only did it set a new industry standard as the first-ever floating, magnetic glass board with no visible hardware, it really came to inspire the use of coloured glass surfaces as a powerful interior design feature.

Since then, both company and collection have grown and diversified significantly, and the portfolio now comprises a wide and continuously expanding range of mutually complementing products, preferred by clients across the globe.

CHAT BOARD remains in family hands, proudly continuing the journey that began more than two decades ago.

Deeply rooted in the Scandinavian design tradition, a CHAT BOARD product embodies an uncompromising commitment to quality in design, materials, and craftsmanship.

We collaborate closely with leading designers on developing beautiful, functional, and innovative designs, all carefully created to enhance and nurture creative dialogue between people in both professional and domestic settings.

Every piece in the collection is hand finished and quality-controlled at our factory just outside Copenhagen, while raw materials are sourced from a few handpicked suppliers, locally and within the EU. Besides giving us complete control of our supply chain, this helps to ensure the unrivalled and consistent quality of our products, while allowing us to keep lead times at a highly competitive level, even for custom made solutions.



content

WALL

Dynamic Flex Wall ^{NEW}	6
Classic.....	10
Classic Surfacing.....	13
Matt.....	15
Matt Surfacing.....	18
Elements.....	20
Elements Surfacing.....	23
Classic Crafted.....	25
Orbit.....	28
Ambit ^{NEW}	31
BuzziFelt.....	34
AQsorb ^{NEW}	37

MOBILE & FREESTANDING BOARDS

Sprinter ^{NEW}	41
SQUAD.....	44
SQUAD Solid.....	47
Mobile.....	50
Move Acoustic.....	53
Dynamic.....	56

ACCESSORIES

DISCØ.....	75
Classic Crafted Keeper.....	77
Storage Unit.....	79
Essential Accessories.....	81

USEFUL INFORMATION

Maintenance.....	89
General information.....	90

WALL

wall-mounted boards

Dynamic Flex Wall^{NEW}

As the first of its kind, CHAT BOARD® Dynamic Flex Wall offers both an elegantly framed alternative to the signature wall mounted boards, as well as the option of updating previously acquired boards with a beautifully finished frame in warm and touchable oak wood, instantly and effortlessly changing the look and mood of its surroundings.

Flexible by nature and name alike, Dynamic Flex Wall is fully past-, present- and future-proofed, allowing for continuous updates according to mood and circumstance. Whether it is changing the magnetic board to one of another colour or finish, or simply changing the mounting direction, Dynamic Flex Wall offers unparalleled flexibility and freedom.

Dynamic Flex Wall is available in 5 sizes and is crafted from solid oak wood, finished with a matt PU lacquer. Frames are delivered fully assembled and are easily fitted with the boards of your choice with the same, easy-to-do system applied when mounting boards directly onto a wall surface. As is the case for all wall-mounted boards in the CHAT BOARD collection, Dynamic Flex Wall **can be mounted both horizontally and vertically**. Wood frames and boards are purchased separately, letting you choose between a ready-packaged solution and the ultimate retrofit.

Glass boards are made with 4 mm tempered safety glass, in accordance with the highest quality standards, finished with either smooth C-edges and 4 mm radius corners (Classic and Matt), or with polished V edges and 90° corners (Elements). Choose between a glossy Classic and a velvety Matt finish as well as the palette of 25 (Classic and Matt) or 5 (Elements) standard glass colours. In addition, the glass can also be made to order in bespoke standard RAL or NCS colours, available for glass.

BuzziFelt pin boards are made with 6 mm 100% recycled PET felt which provides a sound-dampening effect, making them the ideal companions for glass boards.

FYI Dynamic Flex Wall may be adapted to fit glass- and ceramic boards from other manufacturers, provided that they have the same measurements and a comparable hanging system.

Please contact our head office with any special requests: info@chat-board.dk



Dynamic Flex Wall^{NEW}

Item no.	Description	Dimensions		Weight kg
		Horizontally mounted W x H x D mm	Vertically mounted W x H x D mm	
1 FRAME - choose size				
DYNFLEXW1082X1082	Dynamic Flex Wall frame in matt lacquered oak wood for wall-mounted boards size 1000 mm x 1000 mm	1082 x 1082 x 45	1082 x 1082 x 45	10.6
DYNFLEXW982X1282	Dynamic Flex Wall frame in matt lacquered oak wood for wall-mounted boards size 900 mm x 1200 mm	1282 x 982 x 45	982 x 1282 x 45	10.7
DYNFLEXW1082X1582	Dynamic Flex Wall frame in matt lacquered oak wood for wall-mounted boards size 1000 mm x 1500 mm	1582 x 1082 x 45	1082 x 1582 x 45	11.6
DYNFLEXW1282X1582	Dynamic Flex Wall frame in matt lacquered oak wood for wall-mounted boards size 1200 mm x 1500 mm	1582 x 1282 x 45	1282 x 1582 x 45	12.0
DYNFLEXW1082X2082	Dynamic Flex Wall frame in matt lacquered oak wood for wall-mounted boards size 1000 mm x 2000 mm	2082 x 1082 x 45	1082 x 2082 x 45	13.1

2 BOARD - choose material and finish in the size to match the frame

Elements	Description	Dimensions		Weight kg
		Horizontally mounted W x H mm	Vertically mounted W x H mm	
MTEL100100	Elements magnetic glass board	1000 x 1000	1000 x 1000	16.0
MTEL90120	Elements magnetic glass board	1200 x 900	900 x 1200	17.8
MTEL100150	Elements magnetic glass board	1500 x 1000	1000 x 1500	26.0
MTEL120150	Elements magnetic glass board	1500 x 1200	1200 x 1500	31.0
MTEL100200	Elements magnetic glass board	2000 x 1000	1000 x 2000	36.0

Classic	Description	Dimensions		Weight kg
		Horizontally mounted W x H mm	Vertically mounted W x H mm	
MT100100	Classic magnetic glass board	1000 x 1000	1000 x 1000	16.0
MT90120	Classic magnetic glass board	1200 x 900	900 x 1200	17.8
MT100150	Classic magnetic glass board	1500 x 1000	1000 x 1500	26.0
MT120150	Classic magnetic glass board	1500 x 1200	1200 x 1500	31.0
MT100200	Classic magnetic glass board	2000 x 1000	1000 x 2000	36.0

Matt	Description	Dimensions		Weight kg
		Horizontally mounted W x H mm	Vertically mounted W x H mm	
MTM100100	Matt magnetic glass board	1000 x 1000	1000 x 1000	16.0
MTM90120	Matt magnetic glass board	1200 x 900	900 x 1200	17.8
MTM100150	Matt magnetic glass board	1500 x 1000	1000 x 1500	26.0
MTM120150	Matt magnetic glass board	1500 x 1200	1200 x 1500	31.0
MTM100200	Matt magnetic glass board	2000 x 1000	1000 x 2000	36.0

BuzziFelt	Description	Dimensions		Weight kg
		Horizontally mounted W x H mm	Vertically mounted W x H mm	
MTBUZZI100100	BuzziFelt magnetic, felt-covered pin board	1000 x 1000	1000 x 1000	6.4
MTBUZZI90120	BuzziFelt magnetic, felt-covered pin board	1200 x 900	900 x 1200	6.9
MTBUZZI100150	BuzziFelt magnetic, felt-covered pin board	1500 x 1000	1000 x 1500	9.5
MTBUZZI120150	BuzziFelt magnetic, felt-covered pin board	1500 x 1200	1200 x 1500	11.4
MTBUZZI100200	BuzziFelt magnetic, felt-covered pin board	2000 x 1000	1000 x 2000	12.7

Mounting kit is included
Add board accessories with a Basic Kit (only available for purchase with a main CHAT BOARD® product):

KITBLACK	Basic kit Black	1 Black Marker Pen, 3 Chrome Magnets
KITWHITE	Basic kit White	1 White Neon Marker Pen, 3 Chrome Magnets
KITBUZZI	Basic kit BuzziFelt	3 Chrome Magnets

Go to page 9 for colours & materials

[return to index](#)

Dynamic Flex Wall^{NEW}

Sizes & orientation

1082 mm x 1082 mm
(for 1000 mm x 1000 mm boards)

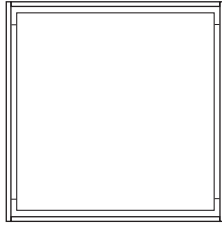

1282 mm x 982 mm / 982 mm x 1282 mm
(for 1200 mm x 900 mm / 900 mm x 1200 mm boards)

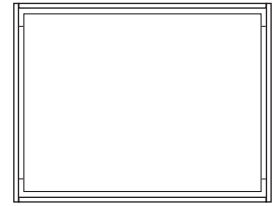
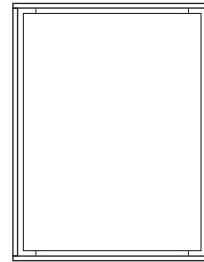

1582 mm x 1082 mm / 1082 mm x 1582 mm
(for 1500 mm x 1000 mm / 1000 mm x 1500 mm boards)

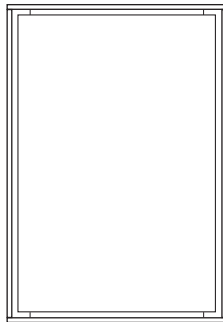

1582 mm x 1282 mm / 1282 mm x 1582 mm
(for 1500 mm x 1200 mm / 1200 mm x 1500 mm boards)

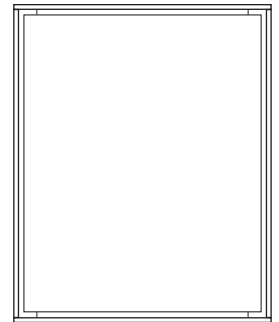
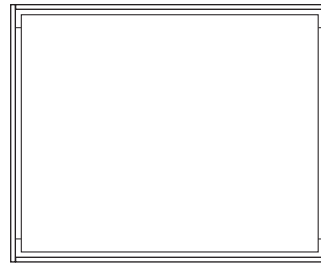

2082 mm x 1082 mm / 1082 mm x 2082 mm
(for 2000 mm x 1000 mm / 1000 mm x 2000 mm boards)

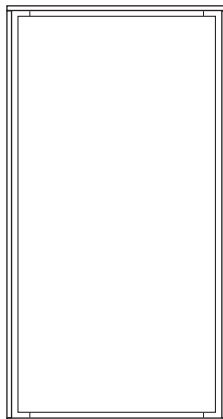
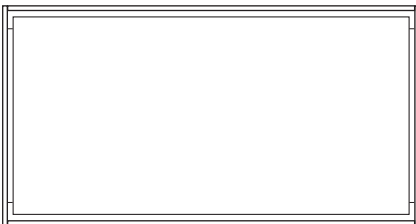

Please note

Unless otherwise clearly requested, the boards will be delivered with mounting kit for horizontal mounting. This can be easily adapted for vertical mounting if needed.

[return to index](#)

Dynamic Flex Wall^{NEW}

Colours & materials

Wood | frame



Oak

Glass | Elements boards



Dove 35 MTDO



Sand 31 MTSA



Khaki 27 MTK



Sky Blue 39 MTSB

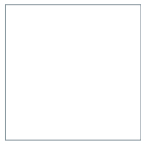

Pure White 14 MTPW

Glass | Classic & Matt boards



Dove MTDO



Grey MTG



Dark Grey MTDG⁽¹⁾



Ink MTINK



Denim MTDE



Lavender MTL



Sky Blue MTSB



Light Blue MTLB



Stone MTSTO



Sand MTSA



Mocca MTM



Black MTS⁽¹⁾



Pine MTPI



Army Green MTAG



Khaki MTK



Lily MTLI



Nude MTNU



Blush MTBL



Petal MTPE



Plum MTPLU



Ruby MTRU



Red MTR



Orange MTO



Yellow MTY

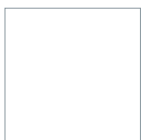

Pure White MTPW

⁽¹⁾We recommend the Basic Kit White

Felt | BuzziFelt boards



63 Off White

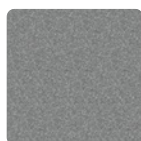

67 Stone Grey

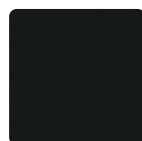

68 Anthracite

Classic

CHAT BOARD® Classic inspires and facilitates creative dialogue between people and minds. Specially designed to help generate, visualise, organise, and exchange ideas and information, it provides the perfect finishing touch in any office-, meeting- or breakout space.

The design is sleekly elegant and deceptively simple; each element has a clear function, and nothing is superfluous. And the smooth, magnetic glass surface offers the most satisfying writing- and drawing experience you'll ever have. Unrivalled in quality and durability, it comes with the added bonus of being easy to clean, helping to give it its long lifespan and making it the definitive replacement for any whiteboard.

CHAT BOARD® Classic is made with 4 mm tempered safety glass, in accordance with the highest quality standards, finished with smooth C-edges and 4 mm radius corners. It can be mounted both horizontally and vertically on the wall, is easily switched from one orientation to another, and is available in 13 standard sizes and 25 standard colours. In addition, it can be made to order in bespoke sizes, shapes and standard RAL and NCS glass colours.

Please contact our head office with any special requests: info@chat-board.dk

Quality test

Security: EN 14434:2010



Cradle to Cradle Certified™ is a certification mark licensed by the Cradle to Cradle Products Innovation Institute



Classic

Item no.	Description	Dimensions		Weight kg
		Horizontally mounted	Vertically mounted	
		W x H mm	W x H mm	
MT5080	Classic magnetic glass board	800 x 500	500 x 800	6.8
MT7070	Classic magnetic glass board	695 x 695	695 x 695	7.8
MT7090	Classic magnetic glass board	900 x 700	700 x 900	11.0
MT58120	Classic magnetic glass board	1200 x 585	585 x 1200	12.5
MT60150	Classic magnetic glass board	1500 x 600	600 x 1500	14.4
MT100100	Classic magnetic glass board	1000 x 1000	1000 x 1000	16.0
MT90120	Classic magnetic glass board	1200 x 900	900 x 1200	17.8
MT120120	Classic magnetic glass board	1200 x 1200	1200 x 1200	25.8
MT100150	Classic magnetic glass board	1500 x 1000	1000 x 1500	26.0
MT120150	Classic magnetic glass board	1500 x 1200	1200 x 1500	31.0
MT100200	Classic magnetic glass board	2000 x 1000	1000 x 2000	36.0
MT120200	Classic magnetic glass board	2000 x 1200	1200 x 2000	43.0
MT120240	Classic magnetic glass board	2400 x 1200	1200 x 2400	46.0
Mounting kit is included Add accessories with a Basic Kit (only available for purchase with a main CHAT BOARD® product):		Total depth (glass front to wall surface): 16 mm (+/- 1 mm)		
KITBLACK	Basic kit Black	1 Black Marker Pen, 3 Chrome Magnets		
KITWHITE	Basic kit White	1 White Neon Marker Pen, 3 Chrome Magnets		

Glass

							
Dove MTDO	Grey MTG	Dark Grey MTDG ⁽¹⁾	Ink MTINK	Denim MTDE	Lavender MTL	Sky Blue MTSB	Light Blue MTLB
							
Stone MTSTO	Sand MTSA	Mocca MTM	Black MTS ⁽¹⁾	Pine MTP	Army Green MTAG	Khaki MTK	Lily MTLI
							
Nude MTNU	Blush MTBL	Petal MTPE	Plum MTPLU	Ruby MTRU	Red MTR	Orange MTO	Yellow MTY
							
Pure White MTPW							

⁽¹⁾we recommend the Basic Kit White

Classic

Sizes & orientation

800 mm x 500 mm / 500 mm x 800 mm

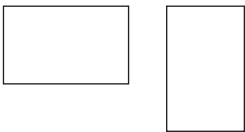

695 mm x 695 mm



900 mm x 700 mm / 700 mm x 900 mm

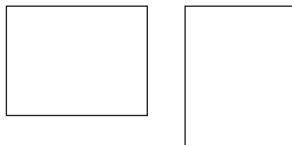

1200 mm x 585 mm / 585 mm x 1200 mm

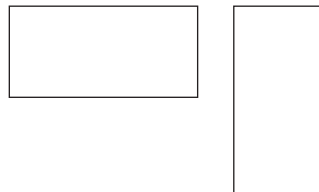

1500 mm x 600 mm / 600 mm x 1500 mm

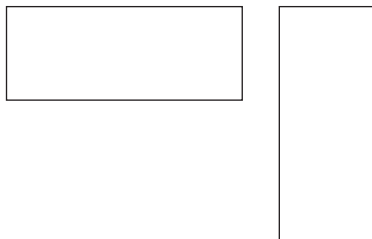

1200 mm x 900 mm / 900 mm x 1200 mm

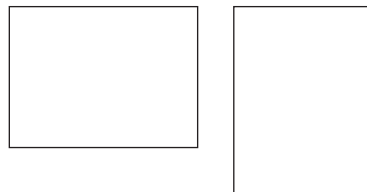

1000 mm x 1000 mm



1500 mm x 1000 mm / 1000 mm x 1500 mm

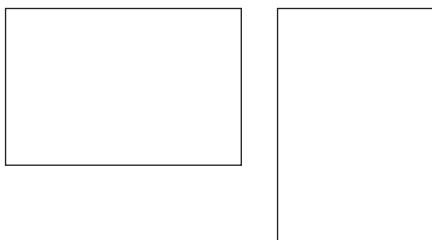

2000 mm x 1000 mm / 1000 mm x 2000 mm

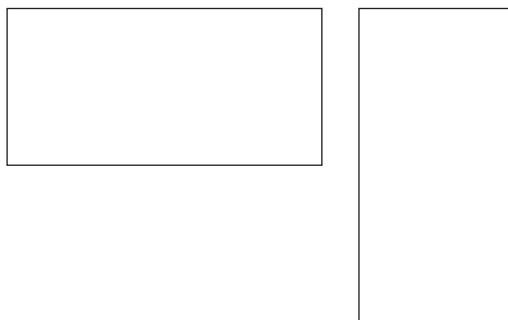

1200 mm x 1200 mm

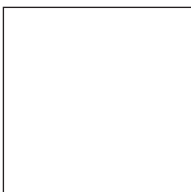

1500 mm x 1200 mm / 1200 mm x 1500 mm

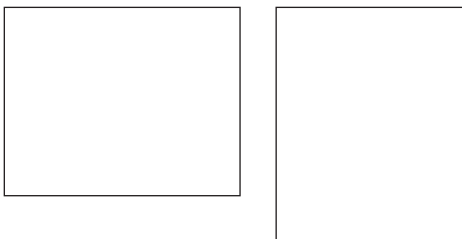

2000 mm x 1200 mm / 1200 mm x 2000 mm

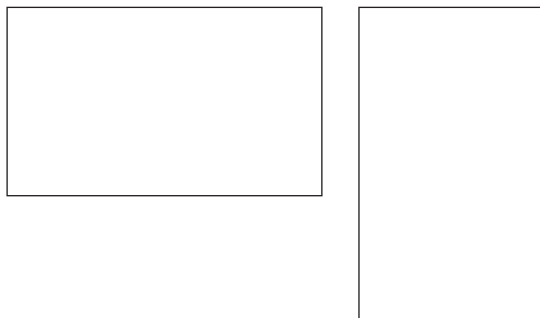

2400 mm x 1200 mm / 1200 mm x 2400 mm

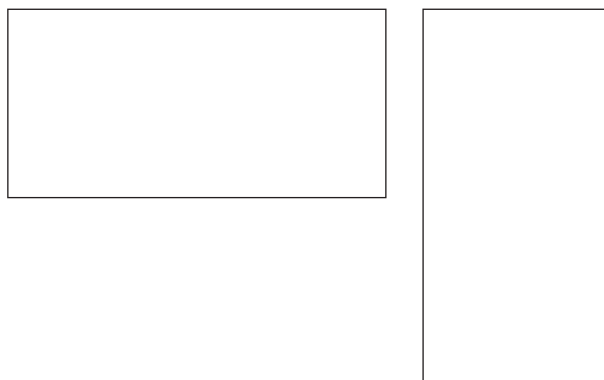

Please note

Unless otherwise clearly requested, the boards will be delivered with a hanging rail for horizontal mounting. This can be easily cut shorter for vertical mounting if needed.

Classic Surfacing

CHAT BOARD® Classic Surfacing provides the ideal solution for converting larger wall spaces into creative surfaces on a grand scale. Combine up to 5 pieces of the 1000 x 2000 mm Classic board in the colour(s) of your choice to create personalised wall compositions that are an exact match for your specific requirements.

CHAT BOARD® Classic Surfacing is composed of Classic boards made with 4 mm tempered safety glass, in accordance with the highest quality standards, finished with smooth C-edges and 4 mm radius corners. As a standard they are mounted vertically on the wall, but they can also be used horizontally if needed. The Classic Surfacing boards each measure 1000 x 2000 mm and they are available in 25 standard colours, which can be combined as desired. In addition, they can be made to order in bespoke standard RAL and NCS glass colours.

Please contact our head office with any special requests: info@chat-board.dk

Quality test

Security: EN 14434:2010



Cradle to Cradle Certified™ is a certification mark licensed by the Cradle to Cradle Products Innovation Institute



Classic Surfacing

Item no.	Description	Dimensions	Weight
		(Vertically mounted)	Total
		W x H mm	kg
MTSURF2	Classic Surfacing - 2 magnetic glass boards	2000 x 2000	72.0
MTSURF3	Classic Surfacing - 3 magnetic glass boards	3000 x 2000	108.0
MTSURF4	Classic Surfacing - 4 magnetic glass board	4000 x 2000	144.0
MTSURF5	Classic Surfacing - 5 magnetic glass board	5000 x 2000	180.0
Mounting kits are included Add accessories with a Basic Kit (only available for purchase with a main CHAT BOARD® product):		Total depth (glass front to wall surface): 16 mm (+/- 1 mm)	
KITBLACK	Basic kit Black	1 Black Marker Pen, 3 Chrome Magnets	
KITWHITE	Basic kit White	1 White Neon Marker Pen, 3 Chrome Magnets	

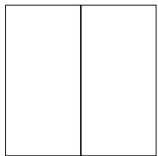

Classic Surfacing - 2
W 2000 mm x H 2000mm

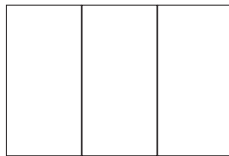

Classic Surfacing - 3
W 3000 mm x H 2000 mm

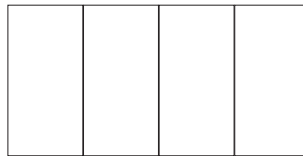

Classic Surfacing - 4
W 4000 mm x H 2000 mm

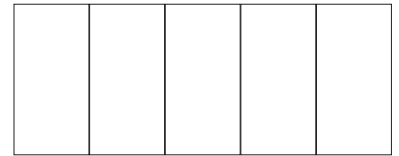

Classic Surfacing - 5
W 5000 mm x H 2000 mm

Glass



Dove MTDO



Grey MTG



Dark Grey MTDG⁽¹⁾



Ink MTINK



Denim MTDE



Lavender MTL



Sky Blue MTSB



Light Blue MTLB

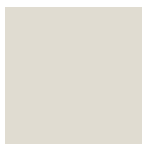

Stone MTSTO



Sand MTSA



Mocca MTM



Black MTS⁽¹⁾



Pine MTP



Army Green MTAG



Khaki MTK



Lily MTL



Nude MTNU



Blush MTBL



Petal MTPE



Plum MTPLU



Ruby MTRU



Red MTR



Orange MTO



Yellow MTY

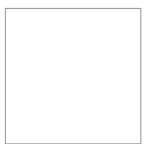

Pure White MTPW

⁽¹⁾we recommend the Basic Kit White

Matt

CHAT BOARD® Matt, like its glossier counterpart Classic, is the ideal tool for illustrating, sharing and communicating creative ideas and thoughts, as well as providing any kind of practical information in any imaginable workspace or domestic setting. What really sets it apart, however, is the elegantly matt, yet velvety smooth, surface, which ensures minimal reflection or glare. Equally easy to clean and maintain, the CHAT BOARD® Matt will remain a pleasure to use and look at for years to come.

CHAT BOARD® Matt is made with 4 mm tempered safety glass, in accordance with the highest quality standards, finished with smooth C-edges and 4 mm radius corners. It can be mounted both horizontally and vertically on the wall, is easily switched from one orientation to another, and is available in 11 standard sizes and 25 standard colours. In addition, it can be made to order in bespoke sizes, shapes and standard RAL and NCS glass colours.

Please contact our head office with any special requests: info@chat-board.dk

Quality test

Security: EN 14434:2010



Cradle to Cradle Certified™ is a certification mark licensed by the Cradle to Cradle Products Innovation Institute



Matt

Item no.	Description	Dimensions		Weight kg
		Horizontally mounted	Vertically mounted	
		W x H mm	W x H mm	
MTM7090	Matt magnetic glass board	900 x 700	700 x 900	11.0
MTM58120	Matt magnetic glass board	1200 x 585	585 x 1200	12.5
MTM60150	Matt magnetic glass board	1500 x 600	600 x 1500	14.4
MTM100100	Matt magnetic glass board	1000 x 1000	1000 x 1000	16.0
MTM90120	Matt magnetic glass board	1200 x 900	900 x 1200	17.8
MTM120120	Matt magnetic glass board	1200 x 1200	1200 x 1200	25.8
MTM100150	Matt magnetic glass board	1500 x 1000	1000 x 1500	26.0
MTM120150	Matt magnetic glass board	1500 x 1200	1200 x 1500	31.0
MTM100200	Matt magnetic glass board	2000 x 1000	1000 x 2000	36.0
MTM120200	Matt magnetic glass board	2000 x 1200	1200 x 2000	43.0
MTM120240	Matt magnetic glass board	2400 x 1200	1200 x 2400	46.0
Mounting kit is included Add accessories with a Basic Kit (only available for purchase with a main CHAT BOARD® product):		Total depth (glass front to wall surface): 16 mm (+/- 1 mm)		
KITBLACK	Basic kit Black	1 Black Marker Pen, 3 Chrome Magnets		
KITWHITE	Basic kit White	1 White Neon Marker Pen, 3 Chrome Magnets		

Optional choose Elements finish for Matt (with polished V edges and 90° corners)

Glass

							
Dove MTDO	Grey MTG	Dark Grey MTDG ⁽¹⁾	Ink MTINK	Denim MTDE	Lavender MTL	Sky Blue MTSB	Light Blue MTLB
							
Stone MTSTO	Sand MTSA	Mocca MTM	Black MTS ⁽¹⁾	Pine MTPI	Army Green MTAG	Khaki MTK	Lily MTLI
							
Nude MTNU	Blush MTBL	Petal MTPE	Plum MTPLU	Ruby MTRU	Red MTR	Orange MTO	Yellow MTY
							
Pure White MTPW							

⁽¹⁾we recommend the Basic Kit White

Matt

Sizes & orientation

900 mm x 700 mm / 700 mm x 900 mm

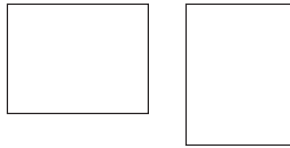

1200 mm x 585 mm / 585 mm x 1200 mm

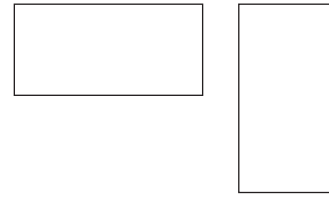

1500 mm x 600 mm / 600 mm x 1500 mm

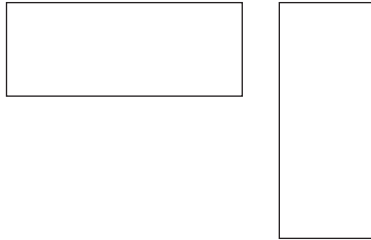

1200 mm x 900 mm / 900 mm x 1200 mm

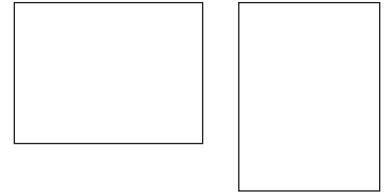

1000 mm x 1000 mm

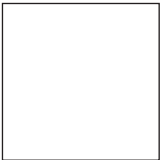

1500 mm x 1000 mm / 1000 mm x 1500 mm

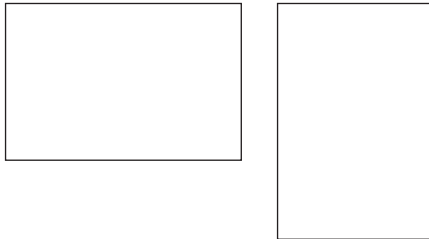

2000 mm x 1000 mm / 1000 mm x 2000 mm

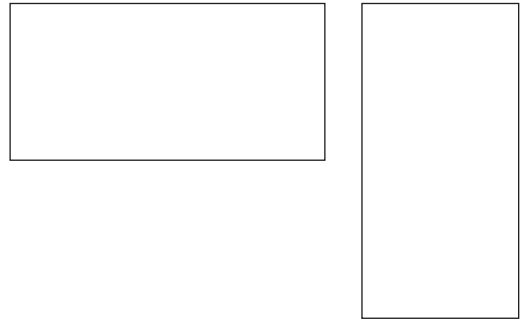

1200 mm x 1200 mm

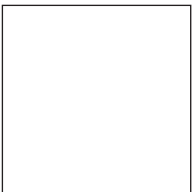

1500 mm x 1200 mm / 1200 mm x 1500 mm

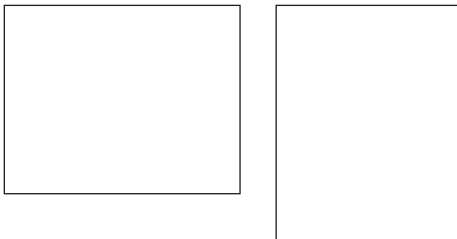

2000 mm x 1200 mm / 1200 mm x 2000 mm

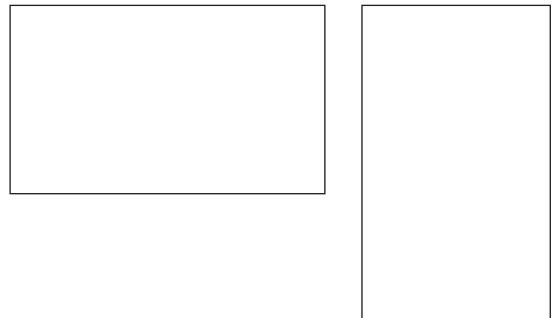

2400 mm x 1200 mm / 1200 mm x 2400 mm

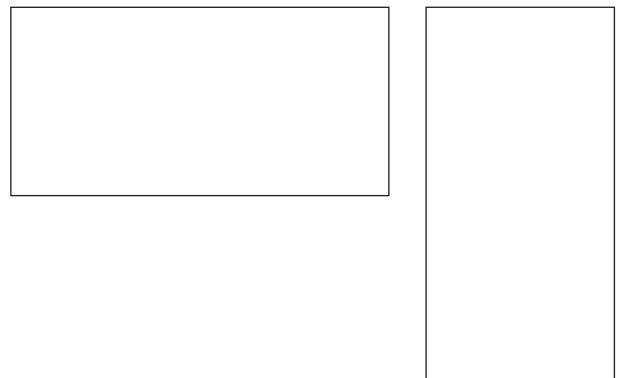

Please note

Unless otherwise clearly requested, the boards will be delivered with a hanging rail for horizontal mounting. This can be easily cut shorter for vertical mounting if needed.

Matt Surfacing

CHAT BOARD® Matt Surfacing provides the ideal solution for converting larger wall spaces into creative surfaces on a grand scale. Combine up to 5 pieces of the 1000 x 2000 mm Matt board in the colour(s) of your choice to create personalised wall compositions that are an exact match for your specific requirements.

CHAT BOARD® Matt Surfacing is composed of Matt boards made with 4 mm tempered safety glass, in accordance with the highest quality standards, finished with smooth C-edges and 4 mm radius corners. As a standard they are mounted vertically on the wall, but they can also be used horizontally if needed. The Matt Surfacing boards each measure 1000 x 2000 mm and they are available in 25 standard colours, which **can be combined as desired**. In addition, they can be made to order in bespoke standard RAL and NCS glass colours.

Please contact our head office with any special requests: info@chat-board.dk

Quality test

Security: EN 14434:2010



Cradle to Cradle Certified™ is a certification mark licensed by the Cradle to Cradle Products Innovation Institute



Matt Surfacing

Item no.	Description	Dimensions	Weight
		(Vertically mounted)	Total
		W x H mm	kg
MTMSURF2	Matt Surfacing - 2 magnetic glass boards	2000 x 2000	72.0
MTMSURF3	Matt Surfacing - 3 magnetic glass boards	3000 x 2000	108.0
MTMSURF4	Matt Surfacing - 4 magnetic glass board	4000 x 2000	144.0
MTMSURF5	Matt Surfacing - 5 magnetic glass board	5000 x 2000	180.0
Mounting kits are included Add accessories with a Basic Kit for each board (only available for purchase with a main CHAT BOARD® product):		Total depth (glass front to wall surface): 16 mm (+/- 1 mm)	
KITBLACK	Basic kit Black	1 Black Marker Pen, 3 Chrome Magnets	
KITWHITE	Basic kit White	1 White Neon Marker Pen, 3 Chrome Magnets	

Optional choose Elements finish for Matt Surfacing (with polished V edges and 90° corners)

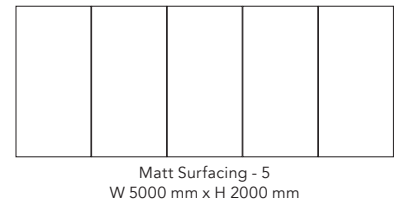
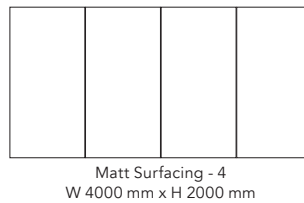
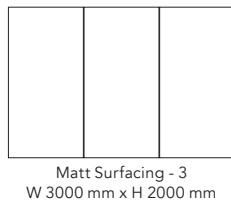
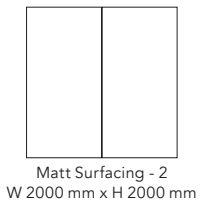

Glass



⁽¹⁾we recommend the Basic Kit White

Elements

CHAT BOARD® Elements offers the same advantages and high quality as our Classic magnetic glass boards, in an updated design with a slightly simplified edge- and corner finish. The clean glass surface provides the perfect backdrop for visualising and communicating ideas and information in meeting-, education- or brainstorming sessions.

CHAT BOARD® Elements is made with 4 mm tempered safety glass, in accordance with the highest quality standards, finished with smooth V edges and 90° corners. It comes in a total of 5 standard colours and 6 standard sizes, which **can all be mounted both horizontally and vertically**. In addition, Elements can be made to order in bespoke sizes, shapes and standard RAL and NCS glass colours.

Please contact our head office with any special requests: info@chat-board.dk

Quality test

Security: EN 14434:2010



Cradle to Cradle Certified™ is a certification mark licensed by the Cradle to Cradle Products Innovation Institute



Elements

Item no.	Description	Dimensions		Weight kg
		Horizontally mounted W x H mm	Vertically mounted W x H mm	
MTEL100100	Elements magnetic glass board	1000 x 1000	1000 x 1000	16.0
MTEL90120	Elements magnetic glass board	1200 x 900	900 x 1200	17.8
MTEL100150	Elements magnetic glass board	1500 x 1000	1000 x 1500	26.0
MTEL120150	Elements magnetic glass board	1500 x 1200	1200 x 1500	31.0
MTEL100200	Elements magnetic glass board	2000 x 1000	1000 x 2000	36.0
MTEL120200	Elements magnetic glass board	2000 x 1200	1200 x 2000	43.0
Mounting kit is included Add accessories with a Basic Kit (only available for purchase with a main CHAT BOARD® product):		Total depth (glass front to wall surface): 16 mm (+/- 1 mm)		
KITBLACK	Basic kit Black	1 Black Marker Pen, 3 Chrome Magnets		

Glass



Edges - detail



Elements finish w. V edges vs. Classic (standard) finish w. C edges

Elements

Sizes & orientation

1200 mm x 900 mm / 900 mm x 1200 mm

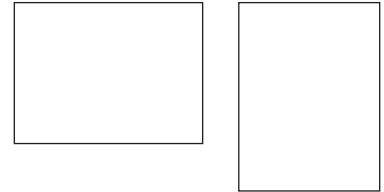

1000 mm x 1000 mm

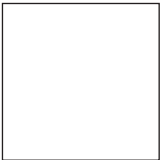

1500 mm x 1000 mm / 1000 mm x 1500 mm

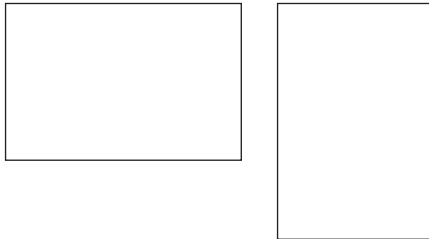

2000 mm x 1000 mm / 1000 mm x 2000 mm

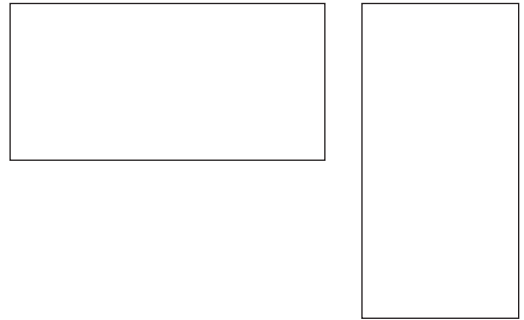

1500 mm x 1200 mm / 1200 mm x 1500 mm

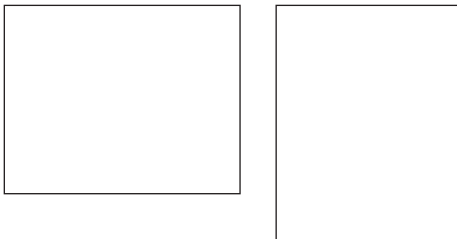

2000 mm x 1200 mm / 1200 mm x 2000 mm

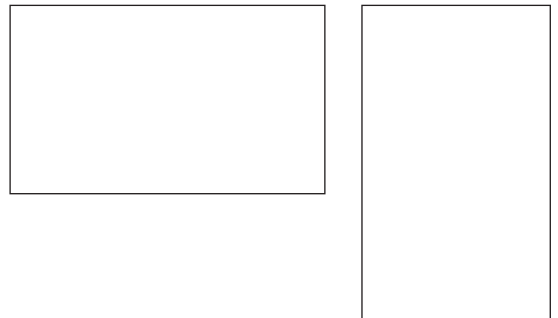

Please note

Unless otherwise clearly requested, the boards will be delivered with a hanging rail for horizontal mounting. This can be easily cut shorter for vertical mounting if needed.

Elements Surfacing

CHAT BOARD® Elements Surfacing provides the ideal solutions for converting larger wall spaces into creative surfaces on a grand scale. Combine up to 5 pieces of the 1000 x 2000 mm Elements board in the colour(s) of your choice to create personalised wall compositions that are an exact match for your specific requirements.

CHAT BOARD® Elements Surfacing is composed of Elements boards made with 4 mm tempered safety glass, in accordance with the highest quality standards, finished with smooth V edges and 90° corners for an extra close fit. As a standard they are mounted vertically on the wall, but they can also be used horizontally if needed. The Elements Surfacing boards each measure 1000 x 2000 mm and they are available in 5 standard colours, which **can be combined as desired**. In addition, they can be made to order in bespoke standard RAL and NCS glass colours.

Please contact our head office with any special requests: info@chat-board.dk

Quality test

Security: EN 14434:2010



Cradle to Cradle Certified™ is a certification mark licensed by the Cradle to Cradle Products Innovation Institute



Elements Surfacing

Item no.	Description	Dimensions	Weight
		(Vertically mounted)	Total
		W x H mm	kg
MTELSURF2	Elements Surfacing - 2 magnetic glass boards	2000 x 2000	72.0
MTELSURF3	Elements Surfacing - 3 magnetic glass boards	3000 x 2000	108.0
MTELSURF4	Elements Surfacing - 4 magnetic glass board	4000 x 2000	144.0
MTELSURF5	Elements Surfacing - 5 magnetic glass board	5000 x 2000	180.0
Mounting kits are included Add accessories with a Basic Kit for each board (only available for purchase with a main CHAT BOARD® product):		Total depth (glass front to wall surface): 16 mm (+/- 1 mm)	
KITBLACK	Basic kit Black	1 Black Marker Pen, 3 Chrome Magnets	

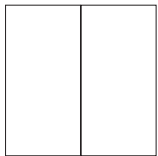

Elements Surfacing - 2
W 2000 mm x H 2000 mm

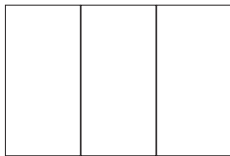

Elements Surfacing - 3
W 3000 mm x H 2000 mm

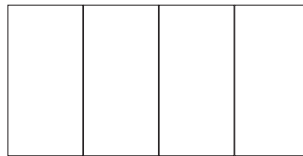

Elements Surfacing - 4
W 4000 mm x H 2000 mm

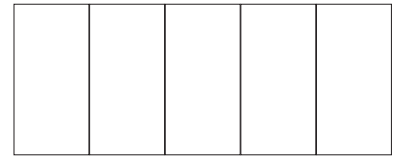

Elements Surfacing - 5
W 5000 mm x H 2000 mm

Glass



Dove MTDO

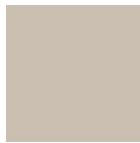

Sand MTSA



Khaki MTK



Sky Blue MTSB

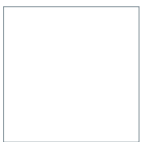

Pure White MTPW

Edges - detail



Elements finish w. V edges vs. Classic (standard) finish w. C edges

Classic Crafted

CHAT BOARD® Classic Crafted brings a whole new perspective to its much-loved forerunner, Classic. Marrying the soft warmth of oak wood, in a natural or black finish, with our signature streamlined glass surface in one cohesive unit, Classic Crafted elegantly elevates the functional to the truly desirable. The four beautifully balanced pieces are all hand finished and tailor made to partner perfectly with other wall-mounted boards in the CHAT BOARD collection, offering endless possibilities to create carefully composed interactive wall surfaces of beauty and utility in equal amounts.

The seamless juxtaposition of contrasting, yet mutually complementing surface textures brings a fresh aesthetic dynamic and definition to the Classic board without taking away from its key function as an indispensable tool for creation and communication.



Complete your Classic Crafted composition with the Classic Crafted Keeper (*see page 77*), an exquisitely shaped, magnetic accessories holder, mirroring the wood veneer panels of the 'mother' board. Fully flexible and easily attached, it can be placed on both panel and glass and moved around according to mood and circumstances.

CHAT BOARD® Classic Crafted is made with 4 mm tempered safety glass, in accordance with the highest quality standards, finished with smooth C-edges and 4 mm radius corners. The wood panels and Keeper are crafted from oak veneer, treated with a matt PU lacquer in the finish of your choice. All Classic Crafted boards can be mounted both horizontally and vertically (with the panel on either side, top or bottom as desired) and easily changed from one orientation to another. Classic Crafted is available in 4 standard sizes and 25 standard glass colours. In addition, they can be made to order in bespoke sizes and standard RAL and NCS glass colours.

Please contact our head office with any special requests: info@chat-board.dk



Classic Crafted



Item no.	Description	Dimensions				Weight kg
		Glass mm	Veneer panel mm	Horizontally mounted W x H mm	Vertically mounted W x H mm	
						
Oak						
MTCRO7090	Classic Crafted magnetic glass board with matt lacquered oak veneer panel	695 x 695	200 x 695	897 x 695	695 x 897	9.2
MTCRO100120	Classic Crafted magnetic glass board with matt lacquered oak veneer panel	1000 x 1000	200 x 1000	1200 x 1000	1000 x 1200	16.5
MTCRO120120	Classic Crafted magnetic glass board with matt lacquered oak veneer panel	900 x 1200	300 x 1200	1200 x 1200	1200 x 1200	19.8
MTCRO120150	Classic Crafted magnetic glass board with matt lacquered oak veneer panel	1200 x 1200	300 x 1200	1500 x 1200	1200 x 1500	24.8
						
Black oak						
MTCRB7090	Classic Crafted magnetic glass board with matt, black lacquered oak veneer panel	695 x 695	200 x 695	897 x 695	695 x 897	9.2
MTCRB100120	Classic Crafted magnetic glass board with matt, black lacquered oak veneer panel	1000 x 1000	200 x 1000	1200 x 1000	1000 x 1200	16.5
MTCRB120120	Classic Crafted magnetic glass board with matt, black lacquered oak veneer panel	900 x 1200	300 x 1200	1200 x 1200	1200 x 1200	19.8
MTCRB120150	Classic Crafted magnetic glass board with matt, black lacquered oak veneer panel	1200 x 1200	300 x 1200	1500 x 1200	1200 x 1500	24.8
Mounting kit is included Add accessories with a Basic Kit (only available for purchase with a main CHAT BOARD® product):		Total depth (glass front to wall surface): 16 mm (+/- 1 mm)				
KITBLACK	Basic kit Black	1 Black Marker Pen, 3 Chrome Magnets				
KITWHITE	Basic kit White	1 White Neon Marker Pen, 3 Chrome Magnets				

Glass Optional add Matt glass to Classic Crafted

							
Dove MTDO	Grey MTG	Dark Grey MTDG ⁽¹⁾	Ink MTINK	Denim MTDE	Lavender MTL	Sky Blue MTSB	Light Blue MTLB
							
Stone MTSTO	Sand MTSA	Mocca MTM	Black MTS ⁽¹⁾	Pine MTPI	Army Green MTAG	Khaki MTK	Lily MTLI
							
Nude MTNU	Blush MTBL	Petal MTPE	Plum MTPLU	Ruby MTRU	Red MTR	Orange MTO	Yellow MTY
							
Pure White MTPW							

⁽¹⁾We recommend the Basic Kit White

Veneer

	
Oak matt lacquered	Black oak matt, black lacquered

Add a Keeper

	
see page 77 for full details	

Classic Crafted

Sizes & orientation

897 mm x 695 mm / 695 mm x 897 mm

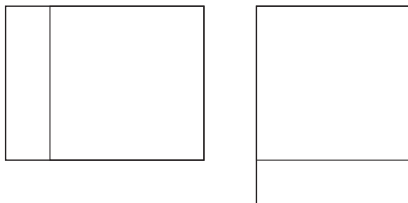

1200 mm x 1000 mm / 1000 mm x 1200 mm

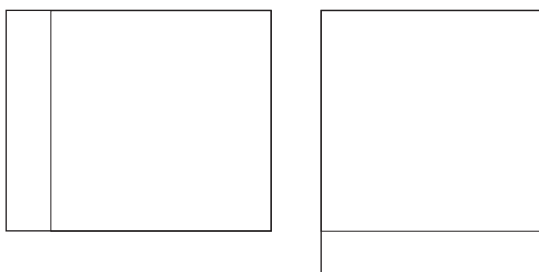

1200 mm x 1200 mm

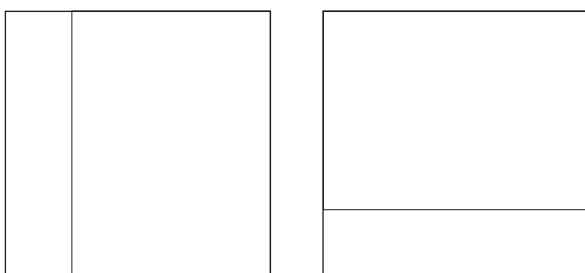

1500 mm x 1200 mm / 1200 mm x 1500 mm

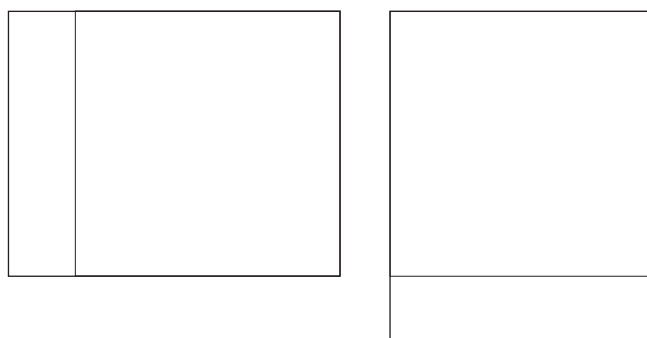

Please note

Unless otherwise clearly requested, the boards will be delivered with a hanging rail for horizontal mounting. This can be easily cut shorter for vertical mounting if needed.

Orbit

CHAT BOARD® Orbit is a playful and slightly less formal interpretation of the magnetic and writable glass board. The strong geometrical shape of the perfect circle offers the ideal starting point for getting truly creative with fun, yet functional wall compositions in professional and domestic settings.

Orbit is dressed in a choice of fresh CHAT BOARD® colours and, along with three complementary sizes, the collection offers countless ways of creating combinations that add that perfectly personalised dimension to your space.

CHAT BOARD® Orbit is made with 4 mm tempered safety glass, in accordance with the highest quality standards, finished with smooth, rounded C-edges. It is available in 3 standard sizes and 7 standard colours. In addition, it can be made to order in other CHAT BOARD colours or bespoke standard RAL and NCS glass colours.

Please contact our head office with any special requests: info@chat-board.dk



Cradle to Cradle Certified™ is a certification mark licensed by the Cradle to Cradle Products Innovation Institute



Orbit

Item no.	Description	Dimensions	Weight
		Ø mm	kg
ORB70	Orbit magnetic glass board	700	6.2
ORB90	Orbit magnetic glass board	900	10.2
ORB120	Orbit magnetic glass board	1200	18.1
Prices include mounting kit Add accessories with a Basic Kit (only available for purchase with a main CHAT BOARD® product):		Total depth (glass front to wall surface): 16 mm (+/- 1 mm)	
KITBLACK	Basic kit Black	1 Black Marker Pen, 3 Chrome Magnets	

Optional add Matt glass to Orbit

Customize with another CHAT BOARD standard colour

Glass



Stone MTSTO

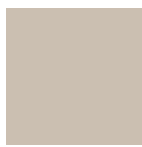

Sand MTSA^{NEW}

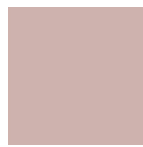

Petal MTPE



Ink MTINK



Pine MTPPI



Khaki MTK^{NEW}



Pure White MTPW

Orbit

Sizes

Ø 700 mm

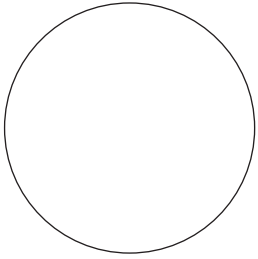

Ø 900 mm

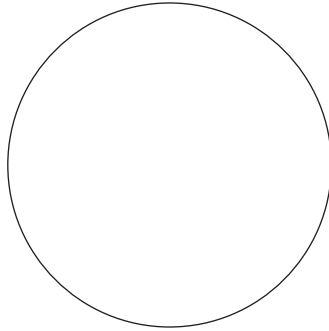

Ø 1200 mm

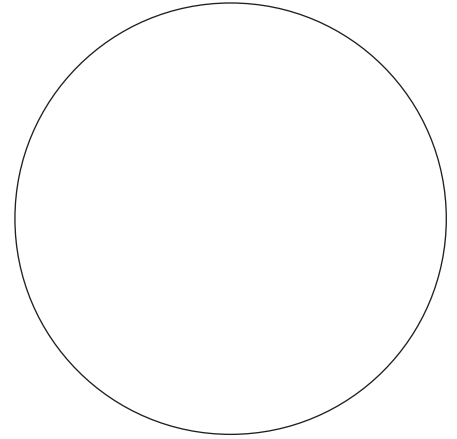

Ambit^{NEW}

CHAT BOARD® Ambit shapes a new approach to the wall-mounted magnetic glass board. As a kindred spirit of the much-loved Orbit collection, it features a similarly curvaceous silhouette, this time transformed into a well-proportioned oval by splitting the circle down the middle and uniting it with a central square.

Ambit evokes that special kind of timeless aesthetic that will instantly add an elegantly understated sense of luxury to its surroundings, making it the perfect final touch to space designs out of the ordinary.

CHAT BOARD® Ambit is made with 4 mm tempered safety glass, in accordance with the highest quality standards, finished with smooth, rounded C-edges. It can be mounted both horizontally and vertically. Ambit is available in 1 standard size and 7 standard colours, but it can also be made to order in other CHAT BOARD colours or bespoke standard RAL and NCS glass colours.

Please contact our head office with any special requests: info@chat-board.dk



Item no.	Description	Dimensions		Weight kg
		Horizontally mounted W x H mm	Vertically mounted W x H mm	
AMB70140	Ambit magnetic glass board	1400 x 700	700 x 1400	14.0
Mounting kit is included Add accessories with a Basic Kit (only available for purchase with a main CHAT BOARD® product):		Total depth (glass front to wall surface): 16 mm (+/- 1 mm)		
KITBLACK	Basic kit Black	1 Black Marker Pen, 3 Chrome Magnets		

Optional add Matt glass to Ambit
 Customize with another CHAT BOARD standard colour

Glass



Stone MTSTO



Sand MTSA



Petal MTPE



Ink MTINK



Pine MTPPI



Khaki MTK



Pure White MTPW

Dimensions

1400 mm x 700 mm / 700 mm x 1400 mm

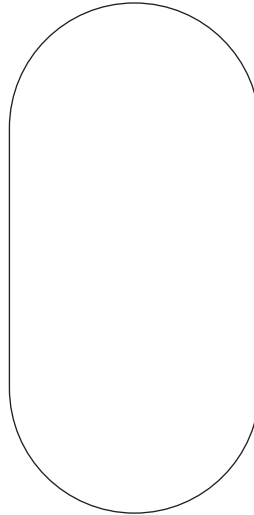

BuzziFelt

CHAT BOARD® BuzziFelt is our wall-mounted, magnetic, felt-covered pinboard. Made with 6 mm 100% recycled PET felt it is also a sound-dampening panel, making it the ideal companion for other wall-mounted boards in the collection. Combined with CHAT BOARD® magnetic glass boards, these felt-covered panels can help turn any office wall into an ultra-functional, multi-textured and dynamic surface.

CHAT BOARD® BuzziFelt **can be mounted both horizontally and vertically** on the wall and is available in 9 standard sizes and 3 standard colours. In addition, it can be made to order in bespoke sizes, shapes and colours.

Please contact our head office with any special requests: info@chat-board.dk



BuzziFelt

Item no.	Description	Dimensions		Weight kg
		Horizontally mounted	Vertically mounted	
		W x H mm	W x H mm	
MTBUZZI20100 ^{NEW}	BuzziFelt magnetic, felt-covered pin board	1000 x 200	200 x 1000	1.3
MTBUZZI30120 ^{NEW}	BuzziFelt magnetic, felt-covered pin board	1200 x 300	300 x 1200	2.3
MTBUZZI60150	BuzziFelt magnetic, felt-covered pin board	1500 x 600	600 x 1500	5.8
MTBUZZI100100	BuzziFelt magnetic, felt-covered pin board	1000 x 1000	1000 x 1000	6.4
MTBUZZI90120	BuzziFelt magnetic, felt-covered pin board	1200 x 900	900 x 1200	6.9
MTBUZZI100150	BuzziFelt magnetic, felt-covered pin board	1500 x 1000	1000 x 1500	9.5
MTBUZZI120150	BuzziFelt magnetic, felt-covered pin board	1500 x 1200	1200 x 1500	11.4
MTBUZZI100200	BuzziFelt magnetic, felt-covered pin board	2000 x 1000	1000 x 2000	12.7
MTBUZZI120200	BuzziFelt magnetic, felt-covered pin board	2000 x 1200	1200 x 2000	15.3
Mounting kit is included Add accessories with a Basic Kit (only available for purchase with a main CHAT BOARD® BuzziFelt product):		Total depth (felt front to wall surface): 18 mm (+/- 1 mm)		
KITBUZZI	Basic kit BuzziFelt	3 Chrome Magnets		

BuzziFelt



63 Off White



67 Stone Grey



68 Anthracite

Sizes & orientation

1000 mm x 200 mm / 200 mm x 1000mm

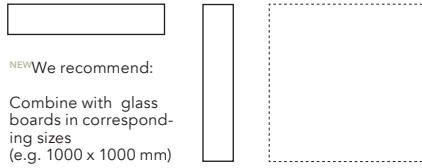

1200 mm x 300 mm / 300 mm x 1200 mm

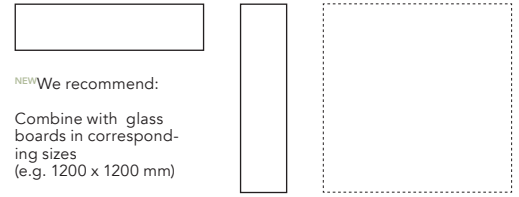

1500 mm x 600 mm / 600 mm x 1500 mm

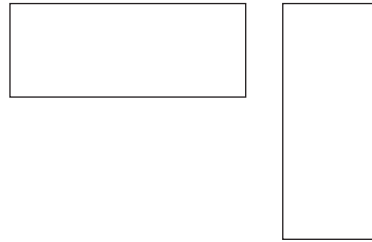

1200 mm x 900 mm / 900 mm x 1200 mm

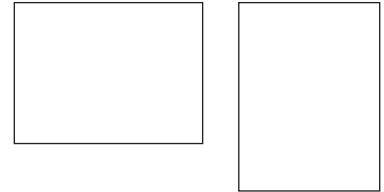

1000 mm x 1000 mm

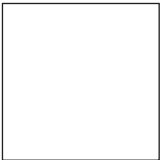

1500 mm x 1000 mm / 1000 mm x 1500 mm

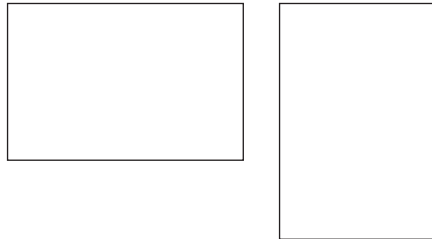

2000 mm x 1000 mm / 1000 mm x 2000 mm

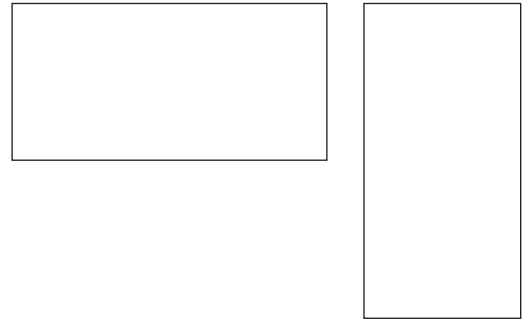

1500 mm x 1200 mm / 1200 mm x 1500 mm

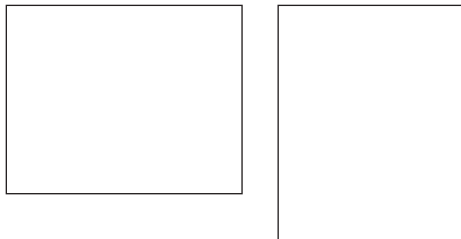

2000 mm x 1200 mm / 1200 mm x 2000 mm



Please note

Unless otherwise clearly requested, the boards will be delivered with a hanging rail for horizontal mounting. This can be easily cut shorter for vertical mounting if needed.

AQsorb®^{NEW}

CHAT BOARD has partnered up with industry experts AQdeco and created a bespoke collaborative collection of AQsorb® acoustic felt panels in a selection of 9 signature sizes, scaled to complement our bestselling glass boards.

An ideal go-to solution when it comes to both simple and decorative absorption in the workspace, AQsorb® panels are manufactured from a lightweight 100% recyclable PET felt (incl. 75% post-consumer content), which effectively improves room acoustics while helping to ensure a healthier indoor environment.

AQsorb is tested in accordance with EN ISO 354 with a sound absorption coefficient (NRC) of 0.85.

The AQsorb® x CHAT BOARD collection includes 9 sizes, each in a choice of 3 versatile shades, handpicked to go hand-in-hand with the most popular glass colours. AQsorb® panels are delivered with matching suspension rails, ready for easy wall installation. They can be mounted both horizontally and vertically. **Please let us know your preferred mounting direction**, so that we can prepare the panels accordingly. Upon request, panels can also be made to order in bespoke sizes, shapes and colours.

NB AQsorb® panels are not magnetic.

Please contact our head office with any special requests: info@chat-board.dk



AQsorb®^{NEW}

Item no.	Description	Dimensions		Weight kg
		Horizontally mounted	Vertically mounted	
		W x H mm	W x H mm	
AQSORB20100	AQsorb® acoustic felt panel	1000 x 200	200 x 1000	0.4
AQSORB30120	AQsorb® acoustic felt panel	1200 x 300	300 x 1200	0.7
AQSORB60150	AQsorb® acoustic felt panel	1500 x 600	600 x 1500	1.5
AQSORB100100	AQsorb® acoustic felt panel	1000 x 1000	1000 x 1000	2.0
AQSORB90120	AQsorb® acoustic felt panel	1200 x 900	900 x 1200	2.2
AQSORB100150	AQsorb® acoustic felt panel	1500 x 1000	1000 x 1500	3.0
AQSORB120150	AQsorb® acoustic felt panel	1500 x 1200	1200 x 1500	3.6
AQSORB100200	AQsorb® acoustic felt panel	2000 x 1000	1000 x 2000	4.0
AQSORB120200	AQsorb® acoustic felt panel	2000 x 1200	1200 x 2000	4.8

Total depth (felt front to wall surface):
18 mm (+/- 1 mm)

AQsorb



AQ35 Light Beige



AQ04 Anthracite

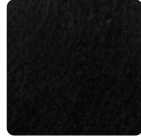

AQ09 Black

Edges - detail



CHAT BOARD x AQsorb® panel edge finish

Sizes & orientation

1000 mm x 200 mm / 200 mm x 1000mm

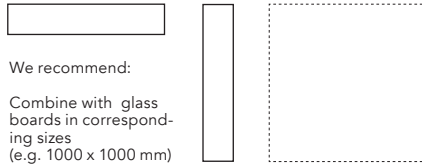

1200 mm x 300 mm / 300 mm x 1200 mm

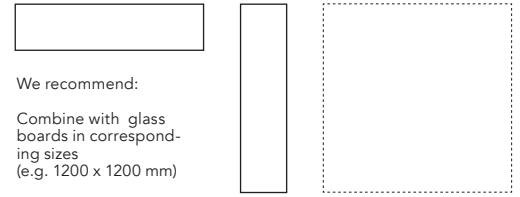

1500 mm x 600 mm / 600 mm x 1500 mm



1200 mm x 900 mm / 900 mm x 1200 mm

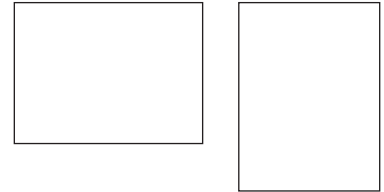

1000 mm x 1000 mm

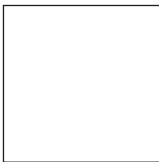

1500 mm x 1000 mm / 1000 mm x 1500 mm

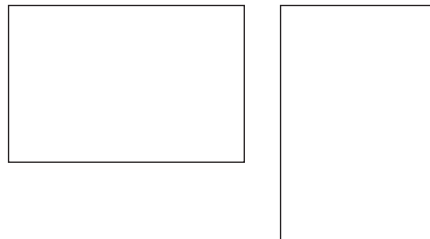

2000 mm x 1000 mm / 1000 mm x 2000 mm

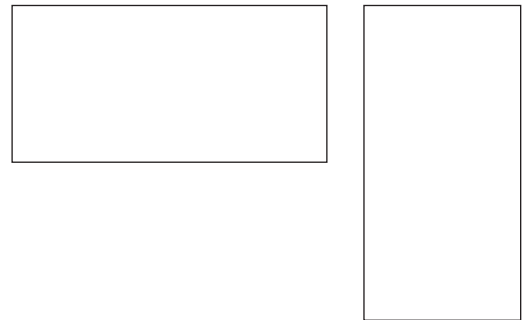

1500 mm x 1200 mm / 1200 mm x 1500 mm

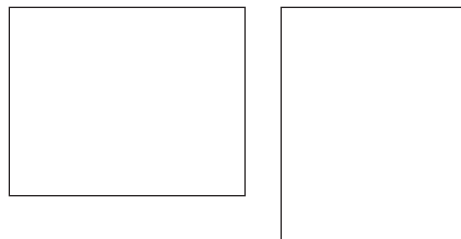

2000 mm x 1200 mm / 1200 mm x 2000 mm

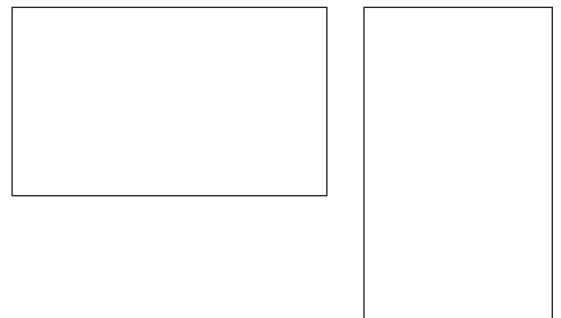

Please note

Please make sure to inform us of your preferred mounting direction, so that panels may be prepared accordingly.

MOBILE & FREESTANDING BOARDS

freestanding, flexible, and multifunctional solutions

Sprinter^{NEW}

Sprinter is the fast-moving and agile new addition to the CHAT BOARD range of freestanding, mobile glass boards. Athletically precise in both shape and performance, it offers a perfectly balanced all-in-one solution, ideal for environments where flexibility is key, be they corporate, creative or educational.

In a pleasingly streamlined design, Sprinter merges monochrome textures of glass and softly powder coated steel in a triumphant trio of appealingly earthy shades that lend themselves perfectly to commercial spaces.

Sprinter was deliberately created in one-size-fits-most dimension that require very limited space while delivering plenty of writing surface. It is based on a light, yet reassuringly stable, tri-pod shaped steel frame, mounted with a magnetic glass board that matches the colour of the structure.

Units are delivered flat packed and easily assembled on site, thus reducing both shipping costs and environmental impact.

CHAT BOARD® Sprinter steel frames are powder coated in Signal White (RAL 9003), (colour equivalent to) Sand or (colour equivalent to) Khaki and mounted with a colour-matching 4 mm tempered safety glass, in accordance with the highest quality standards, finished with smooth C-edges and 4 mm radius corners. They are available in two varieties: a standard version with glossy glass and a version with matt glass. For orders of larger quantities, bespoke colours may be made to order upon request.

Please contact our head office with any special requests: info@chat-board.dk



Sprinter ^{NEW}

Item no.	Description	Dimensions		Weight
		Glass W x H mm	Total size W x H x D mm	
	White steel (RAL 9003) with Pure White glass			
	Glossy glass			
SPRRAL9003	Sprinter magnetic glass board on matching mobile steel base (Pure White)	600 x 1500	635 x 1870 x 574	29.0
	Matt glass			
SPRMRAL9003	Sprinter <i>matt</i> magnetic, glass board on matching mobile steel base (Pure White)	600 x 1500	635 x 1870 x 574	29.0
	Sand (≅) steel with Sand glass			
	Glossy glass			
SPRSAND	Sprinter magnetic glass board on matching mobile steel base (Sand)	600 x 1500	635 x 1870 x 574	29.0
	Matt glass			
SPRMSAND	Sprinter <i>matt</i> magnetic, glass board on matching mobile steel base (Sand)	600 x 1500	635 x 1870 x 574	29.0
	Khaki (≅) steel with Khaki glass			
	Glossy glass			
SPRKHAKI	Sprinter magnetic glass board on matching mobile steel base (Khaki)	600 x 1500	635 x 1870 x 574	29.0
	Matt glass			
SPRMRKHAKI	Sprinter <i>matt</i> magnetic, glass board on matching mobile steel base (Khaki)	600 x 1500	635 x 1870 x 574	29.0
Add accessories with a Basic Kit (only available for purchase with a main CHAT BOARD® product):				
KITBLACK	Basic kit Black	1 Black Marker Pen, 3 Chrome Magnets		



Dimensions

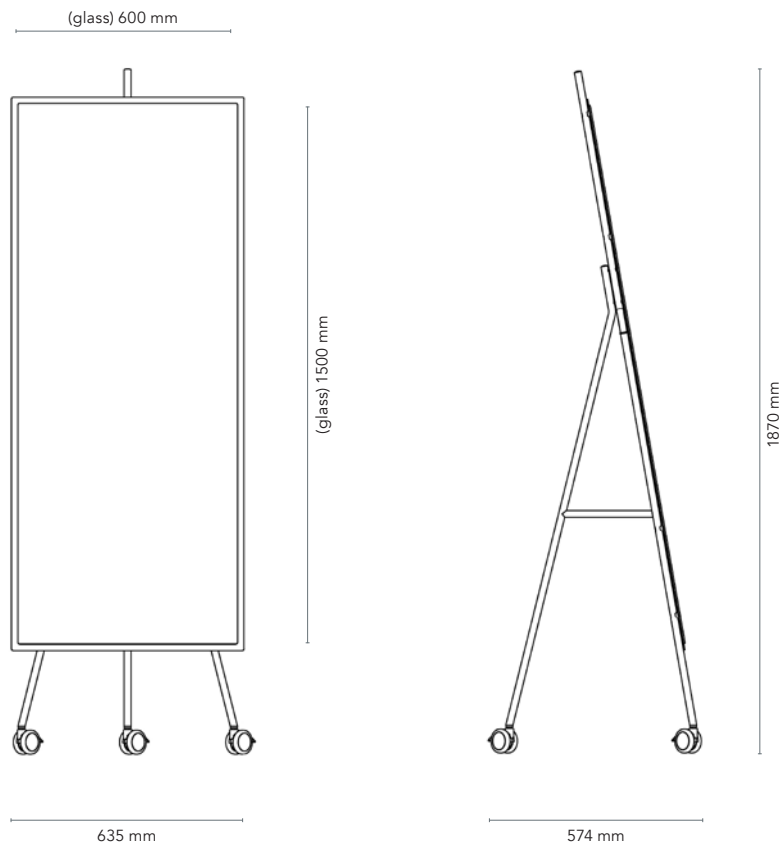

SQUAD

Seamlessly shaped in the Scandinavian tradition of form meeting function in perfect unison, every member of the CHAT BOARD® SQUAD offers the ultimate in effortless functionality and uncompromising aesthetics in a coolly contemporary and streamlined design by Swedish space planners par excellence, RUMRUM. The capsule collection is made up of two freestanding units, and one self-supporting desk divider, all accompanied by their very own storage support team, the SQUAD Collectors.

The design is kept deliberately understated and minimalist. The lightweight, powder coated steel structures serve as elegantly simple, yet multifunctional frames for the writable magnetic glass surfaces of each of the SQUAD units. These are both contrasted and accentuated by perforated steel panels incorporated in the steel structure, boasting a clearly geometrical square pattern design. In SQUAD form equals function, and no feature is without purpose. The Collectors provide easily attachable, essential storage for pens and personal effects while creating an additional vertical pattern that is as individual as the user.

Designed and manufactured in Scandinavia, the SQUAD units are delivered flat packed and easily assembled on site, thus reducing both shipping costs and environmental impact.

The CHAT BOARD® SQUAD steel frames are powder coated in Signal White (RAL 9003) or Jet Black (RAL 9005) and are mounted with 4 mm tempered safety glass, in accordance with the highest quality standards, finished with smooth C-edges and 4 mm radius corners. They are available in 25 standard glass colours, while bespoke glass colours (standard RAL or NCS) can be made to order upon request.

Please contact our head office with any special requests: info@chat-board.dk



Cradle to Cradle Certified™ is a certification mark licensed by the Cradle to Cradle Products Innovation Institute



SQUAD

Item no.	Description	Dimensions		Weight
----------	-------------	------------	--	--------

Mobile- / freestanding units

<div style="display: flex; align-items: center;"> <div style="width: 20px; height: 20px; background-color: #ccc; margin-right: 5px;"></div> <div>White steel (RAL 9003)</div> </div>					Glass W x H mm	Total size (incl. caster wheels) W x H x D mm	kg	
SQRU9003	SQUAD Runner magnetic glass board on a white perforated steel base	585 x 1200	620 x 1892 x 513	24.0				
SQTE9003	SQUAD Teacher magnetic glass board on a white perforated steel base	900 x 1200	1215 x 1830 x 476	39.5				
Optional add-on: caster wheels in White (RAL 9003)			Ø mm					
SQSET39003	set of 3 brake caster wheels for SQUAD Runner in white			65				
SQSET49003	set of 4 brake caster wheels for SQUAD Teacher in white			65				
<div style="display: flex; align-items: center;"> <div style="width: 20px; height: 20px; background-color: #333; margin-right: 5px;"></div> <div>Black steel (RAL 9005)</div> </div>					Glass W x H mm	Total size (incl. caster wheels) W x H x D mm	kg	
SQRU9005	SQUAD Runner magnetic glass board on a black perforated steel base	585 x 1200	620 x 1892 x 513	24.0				
SQTE9005	SQUAD Teacher magnetic glass board on a black perforated steel base	900 x 1200	1215 x 1830 x 476	39.5				
Optional add-on: caster wheels in black (RAL 9005)			Ø mm					
SQSET39005	set of 3 brake caster wheels for SQUAD Runner in black			65				
SQSET49005	set of 4 brake caster wheels for SQUAD Teacher in black			65				
Optional add-on for Teacher (back): extra magnetic glass or BuzziFelt pinboard		W x H mm	kg					
SQTEGLASS	extra magnetic glass for SQUAD Teacher	900 x 1200	11.9					
SQTEBUZZI	sound dampening BuzziFelt pin board for SQUAD Teacher	900 x 1200	1.5					

Desk screens & storage

<div style="display: flex; align-items: center;"> <div style="width: 20px; height: 20px; background-color: #ccc; margin-right: 5px;"></div> <div>White steel (RAL 9003)</div> </div>					Glass & BuzziFelt W x H mm	Total size W x H x D mm	kg	
SQPO9003	SQUAD Poet movable desk divider in white perforated steel with a magnetic glass board and BuzziFelt pin board in Off White	663 x 363	900 x 411 x 142	8.5				
Flexible storage units in white steel (RAL 9003) - can be used with all SQUAD units			W x H x D mm	kg				
SQCOLOW9003	SQUAD Collector Low attachable storage unit in white steel			166 x 36 x 66 0.3				
SQCOHIGH9003	SQUAD Collector High attachable storage unit in white steel			66 x 106 x 66 0.4				
SQCOLONG9003	SQUAD Collector Long attachable storage unit in white steel			166 x 106 x 66 0.5				
<div style="display: flex; align-items: center;"> <div style="width: 20px; height: 20px; background-color: #333; margin-right: 5px;"></div> <div>Black steel (RAL 9005)</div> </div>					Glass & BuzziFelt W x H mm	Total size W x H x D mm	kg	
SQPO9005	SQUAD Poet movable desk divider in black perforated steel with a magnetic glass board and BuzziFelt pin board in Anthracite	663 x 363	900 x 411 x 142	8.5				
Flexible storage units in black steel (RAL 9005) - can be used with all SQUAD units			W x H x D mm	kg				
SQCOLOW9005	SQUAD Collector Low attachable storage unit in black steel			166 x 36 x 66 0.3				
SQCOHIGH9005	SQUAD Collector High attachable storage unit in black steel			66 x 106 x 66 0.4				
SQCOLONG9005	SQUAD Collector Long attachable storage unit in black steel			166 x 106 x 66 0.5				
Add accessories with a Basic Kit (only available for purchase with a main CHAT BOARD® product):								
KITBLACK	Basic kit Black	1 Black Marker Pen, 3 Chrome Magnets						
KITWHITE	Basic kit White	1 White Neon Marker Pen, 3 Chrome Magnets						
KITBUZZI	Basic kit BuzziFelt	3 Chrome Magnets						

Optional add Matt glass to SQUAD

Go to the next page for all SQUAD colour options

[return to index](#)

SQUAD

Variants, dimensions & colours

SQUAD Runner

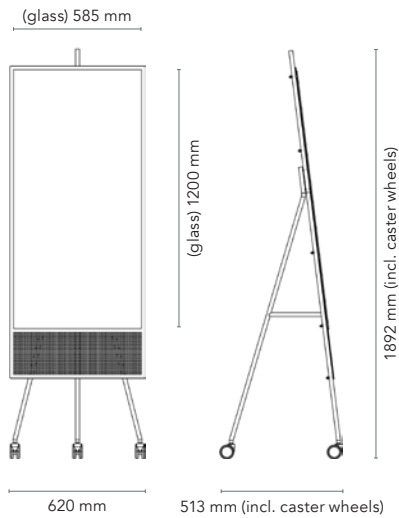

SQUAD Teacher

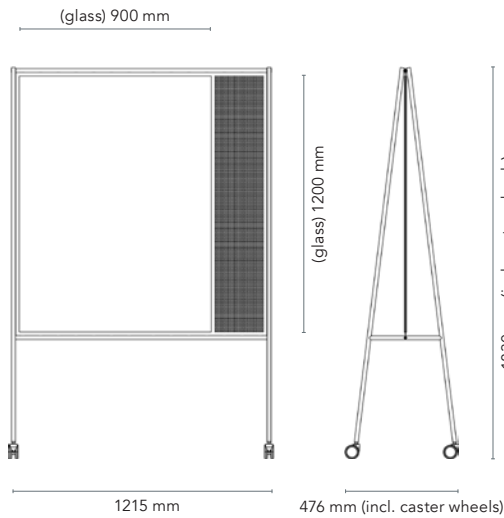

SQUAD Poet

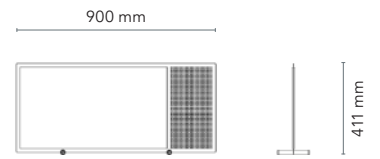

Please note

Unless otherwise clearly requested, the perforated steel panel on the Teacher will always be on the right-hand side of the glass (front).

Glass

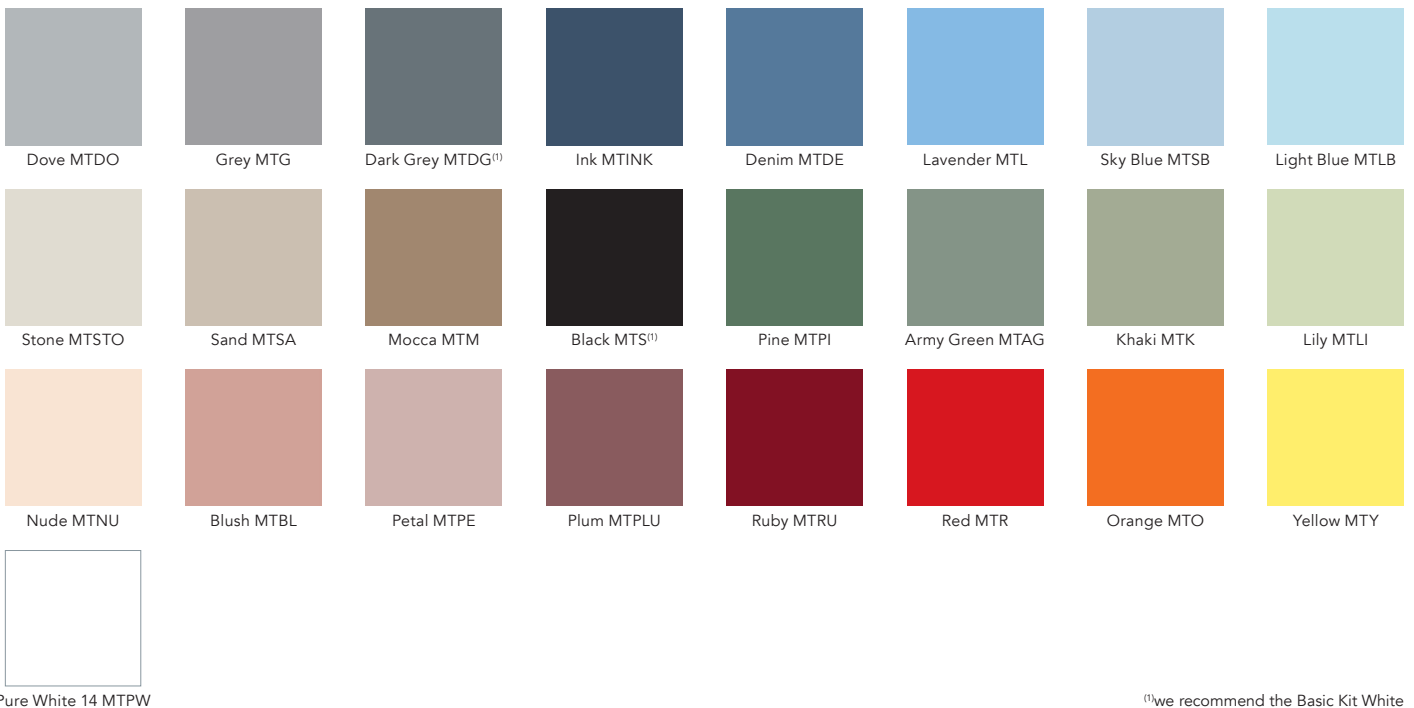

⁽¹⁾we recommend the Basic Kit White

Steel



BuzziFelt (optional for Teacher)



[return to index](#)

SQUAD Solid

With CHAT BOARD® SQUAD Solid we have taken the SQUAD collection to the next level of accessibility and effortlessness. Peeling away any hint of excess, the design has been brought back to its essence, only to resurface in a core collection of pared-back pieces with full focus on their key function: providing the ideal starting point for creative expression and interaction.

SQUAD Solid is based 1:1 on the original designs, only reincarnated in clean-cut silhouettes with a strong, minimalist aesthetic approach. Boasting the same qualities and advantages as their counterparts, the two mutually complementing pieces join forces in this dynamic duo of flexible, freestanding units, created to connect and separate as desired.

SQUAD Solid units are delivered flat packed and easily assembled on site, reducing both shipping costs and environmental impact.

The CHAT BOARD® SQUAD Solid steel frames are powder coated in Signal White (RAL 9003) or Jet Black (RAL 9005) and are mounted with 4 mm tempered safety glass, in accordance with the highest quality standards, finished with smooth C-edges and 4 mm radius corners. They are available in 25 standard glass colours, while bespoke glass colours (standard RAL or NCS) can be made to order upon request.



Please contact our head office with any special requests: info@chat-board.dk



Cradle to Cradle Certified™ is a certification mark licensed by the Cradle to Cradle Products Innovation Institute



SQUAD Solid

Item no.	Description	Dimensions		Weight
Mobile- / freestanding units				
		Glass	Total size	
White steel (RAL 9003)		W x H mm	(incl. caster wheels) W x H x D mm	kg
SQSORU9003	SQUAD Solid Runner magnetic glass board on a white steel base	585 x 1200	620 x 1892 x 513	24.0
SQSOTE9003	SQUAD Solid Teacher magnetic glass board on a white steel base	900 x 1200	1215 x 1830 x 476	39.5
Optional add-on: caster wheels - in White (RAL 9003)			Ø mm	
SQSET39003	set of 3 brake caster wheels for SQUAD Solid Runner in white		65	
SQSET49003	set of 4 brake caster wheels for SQUAD Solid Teacher in white		65	
		Glass	Total size	
Black steel (RAL 9005)		W x H mm	(incl. caster wheels) W x H x D mm	kg
SQSORU9005	SQUAD Solid Runner magnetic glass board on a black steel base	585 x 1200	620 x 1892 x 513	24.0
SQSOTE9005	SQUAD Solid Teacher magnetic glass board on a black steel base	900 x 1200	1215 x 1830 x 476	39.5
Optional add-on: caster wheels - in black (RAL 9005)			Ø mm	
SQSET39005	set of 3 brake caster wheels for SQUAD Solid Runner in black		65	
SQSET49005	set of 4 brake caster wheels for SQUAD Solid Teacher in black		65	
Optional add-on for Solid Teacher (back): extra magnetic glass or BuzziFelt pinboard		W x H mm		kg
SQTEGLASS	extra magnetic glass for SQUAD Solid Teacher	900 x 1200		11.9
SQTEBUZZI	sound dampening BuzziFelt pin board for SQUAD Solid Teacher	900 x 1200		1.5
Add accessories with a Basic Kit (only available for purchase with a main CHAT BOARD® product):				
KITBLACK	Basic kit Black	1 Black Marker Pen, 3 Chrome Magnets		
KITWHITE	Basic kit White	1 White Neon Marker Pen, 3 Chrome Magnets		
KITBUZZI	Basic kit BuzziFelt	3 Chrome Magnets		

Optional add Matt glass to SQUAD Solid

Go to the next page for all SQUAD Solid colour options

[return to index](#)

SQUAD Solid

Variants, dimensions & colours

SQUAD Solid Runner

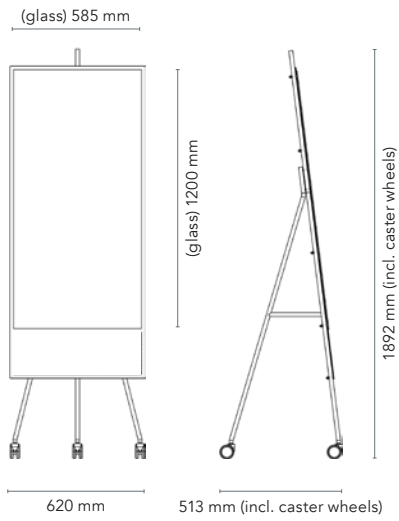

SQUAD Solid Teacher

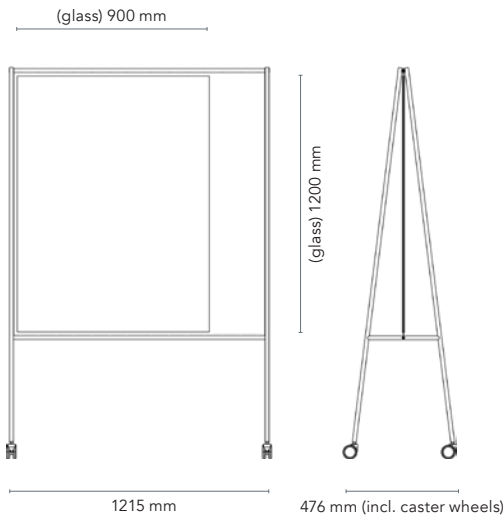

Please note

Unless otherwise clearly requested, the steel panel on the Teacher will always be on the right-hand side of the glass (front).

Glass

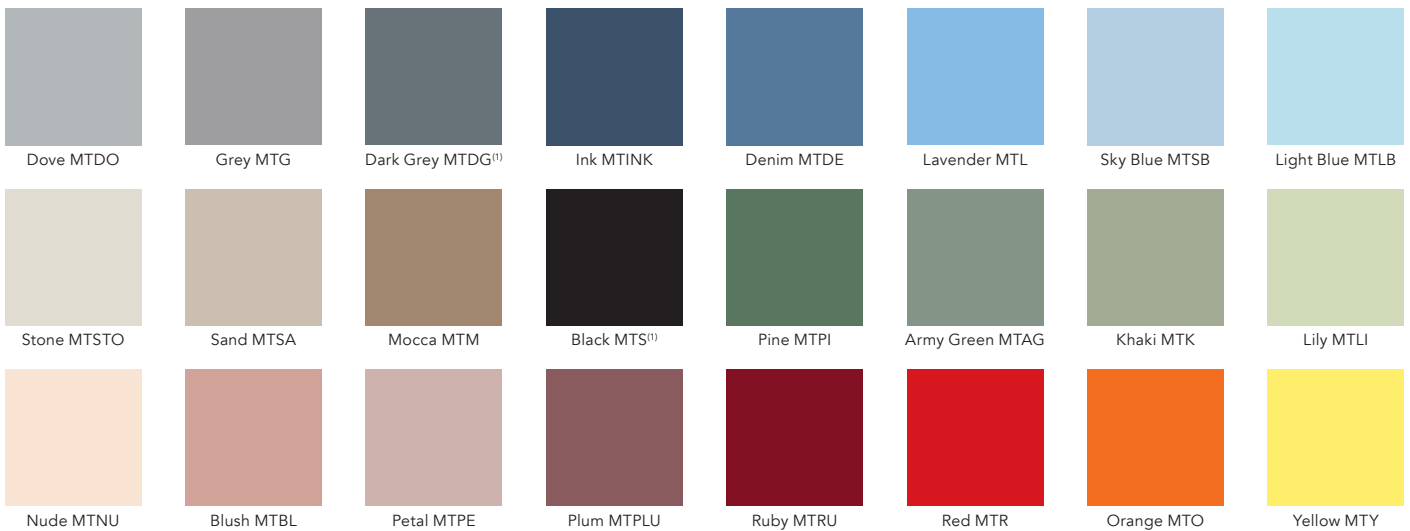

⁽¹⁾we recommend the Basic Kit White

Steel



BuzziFelt (optional for Solid Teacher)



[return to index](#)

Mobile

CHAT BOARD® Mobile provides the ultimate, multi-purpose solution for the dynamic workplace. With its ingenious design, sturdy construction and ultra-stable, yet easily movable, steel base it is virtually impossible to overturn, meaning there is plenty of room to get carried away in the creative process. Besides boasting one of our signature writable, magnetic glass boards on the front, the Mobile can also be fitted with a sound-dampening BuzziFelt pin board, or an additional magnetic glass panel, on the back.

CHAT BOARD® Mobile is made with 4 mm tempered safety glass, in accordance with the highest quality standards, finished with smooth C-edges and 4 mm radius corners. It is available in 2 standard sizes and 25 standard glass colours. In addition, it can be made to order in bespoke standard RAL or NCS glass colours, as well as in alternative RAL base colours, besides the standard Signal White (RAL 9003) and Jet Black (RAL 9005).

Add a digital dimension to Mobile by including a TV bracket (see page 86), preinstalled from the factory and ready for the LCD screen of your choice.



Please contact our head office with any special requests: info@chat-board.dk



Cradle to Cradle Certified™ is a certification mark licensed by the Cradle to Cradle Products Innovation Institute



Mobile

Item no.	Description	Dimensions		Weight
		Glass	Total size	
White steel (RAL 9003)		W x H mm	W x H x D mm	kg
MCBW60	Mobile Executive magnetic glass board on a movable, white steel base	585 x 1200	600 x 1795 x 480	48.0
MCBW120	Mobile Conference magnetic glass board on a movable, white steel base	1200 x 1200	1220 x 1795 x 480	85.0
		Glass	Total size	
Black steel (RAL 9005)		W x H mm	W x H x D mm	kg
MCBB60	Mobile Executive magnetic glass board on a movable, black steel base	585 x 1200	600 x 1795 x 480	48.0
MCBB120	Mobile Conference magnetic glass board on a movable, black steel base	1200 x 1200	1220 x 1795 x 480	85.0
		Glass (back)		
Optional add-on: extra glass (mounted on the back)		W x H mm		kg
BSG60	extra magnetic glass for Mobile Executive (back)	585 x 1200		7.7
BSG120	extra magnetic glass for Mobile Conference (back)	1200 x 1200		15.9
		BuzziFelt (back)		
Optional add-on: BuzziFelt (mounted on the back)		W x H mm		kg
BUZZI60	sound dampening BuzziFelt pin board for Mobile Executive (back)	585 x 1200		1.0
BUZZI120	sound dampening BuzziFelt pin board for Mobile Conference (back)	1200 x 1200		2.0
Add accessories with a Basic Kit (only available for purchase with a main CHAT BOARD® product):				
KITBLACK	Basic kit Black	1 Black Marker Pen, 3 Chrome Magnets		
KITWHITE	Basic kit White	1 White Neon Marker Pen, 3 Chrome Magnets		
KITBUZZI	Basic kit BuzziFelt	3 Chrome Magnets		

Optional add Matt glass to Mobile

Go to the next page for all Mobile colour options

[return to index](#)

Mobile

Variants, dimensions & colours

Mobile Executive

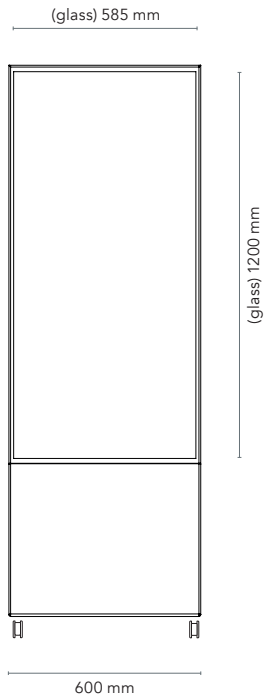

Mobile Conference

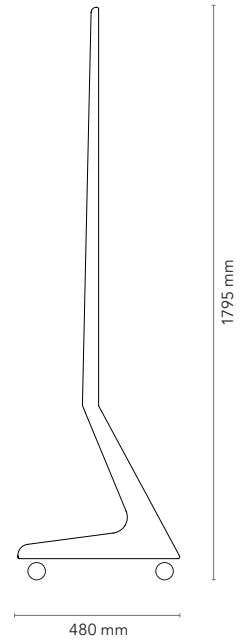
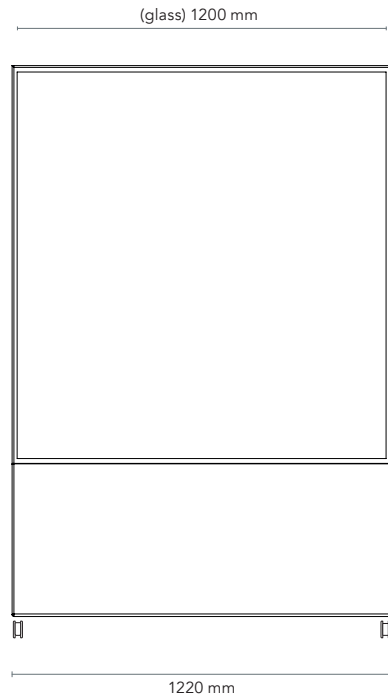

Glass

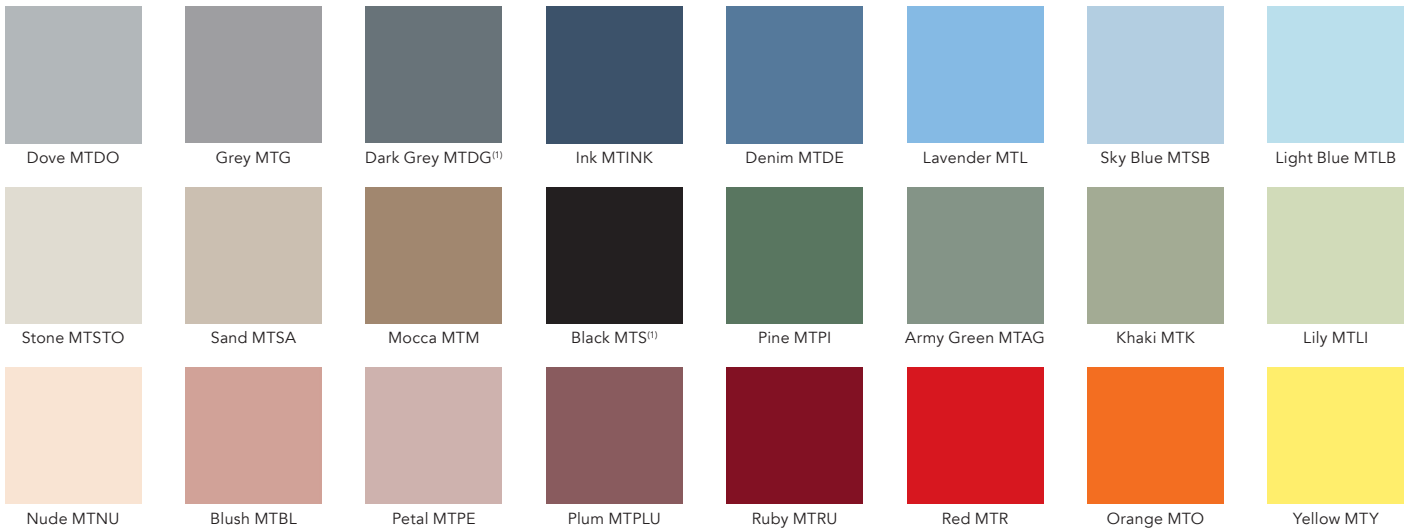

⁽¹⁾we recommend the Basic Kit White

Steel

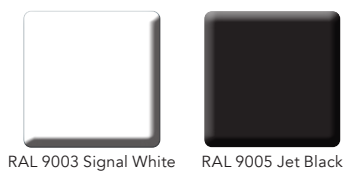

BuzziFelt (optional)



[return to index](#)

Move Acoustic

CHAT BOARD® Move Acoustic seamlessly combines the signature magnetic and writable glass board with a class A acoustic panel in two perfectly proportioned movable room dividers, created to shape multi-functional and creative spaces within spaces. Perfectly finished in Remix Screen (90% new wool, worsted, 10% nylon) or Relate Screen (100% Trevira CS) fabric by Kvadrat and featuring an ingenious, "stackable" cross-base, which allows you to store several units in even the smallest space, Move Acoustic offers style as well as substance without compromising on either.

The writable glass surface is the ideal facilitator of free-flowing brainstorming sessions and provides the obvious focal point of shared ideas and information in the corporate conference room, open office space and classroom alike, while its high-performing acoustic panel ensures the balance in visual and auditory exchange.

The movable aluminium base is powder coated in Jet Black (RAL 9005) and fitted with brake casters for added stability. The glass is 4 mm tempered safety glass, in accordance with the highest quality standards, finished with smooth C-edges and 4 mm radius corners. The wide Move Acoustic comes prepared to be mounted with the TV bracket* of your choice (not included), and both sizes are available in 25 standard glass colours and can also be made to order in bespoke standard RAL or NCS glass colours. The standard assortment includes 6 Remix Screen and 6 Relate Screen fabric colours by Kvadrat, but requests for alternative colours and varieties can be accommodated on demand.

*NB TV screen should not exceed dim. 50"/ W 1110 x H 600 mm

Please contact our head office with any special requests: info@chat-board.dk



Move Acoustic

Item no.	Description	Dimensions		Weight kg
		Glass & panel W x H mm	Total size W x H x D mm	
CBMOVES	Move Acoustic Slim movable room divider with magnetic glass board and acoustic panel	600 x 1500	600 x 1900 x 480	34.0
CBMOVEA	Move Acoustic movable room divider with magnetic glass board and acoustic panel	1200 x 1500	1200 x 1900 x 480	65.0

Add accessories with a Basic Kit
(only available for purchase with a main CHAT BOARD® product):

KITBLACK	Basic kit Black	1 Black Marker Pen, 3 Chrome Magnets		
KITWHITE	Basic kit White	1 White Neon Marker Pen, 3 Chrome Magnets		

Optional add Matt glass to Move Acoustic

Glass



Fabric by Kvadrat

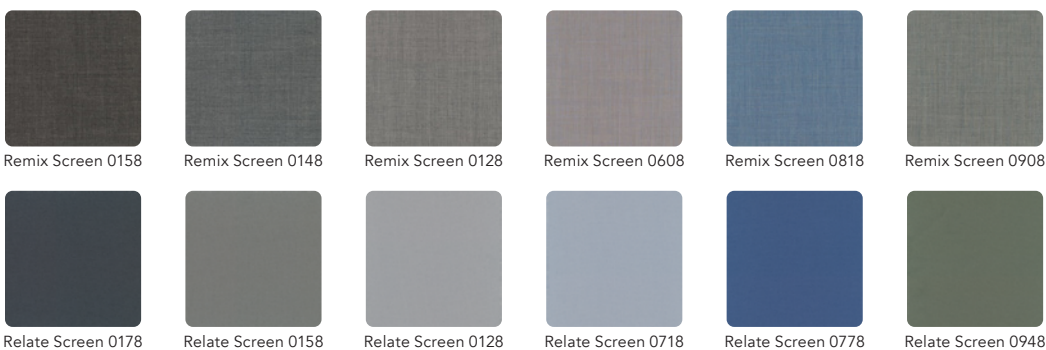

Aluminium



[return to index](#)

Move Acoustic

Variants & dimensions

Move Acoustic Slim

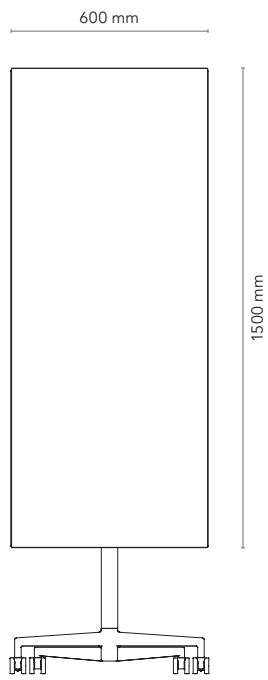

Move Acoustic

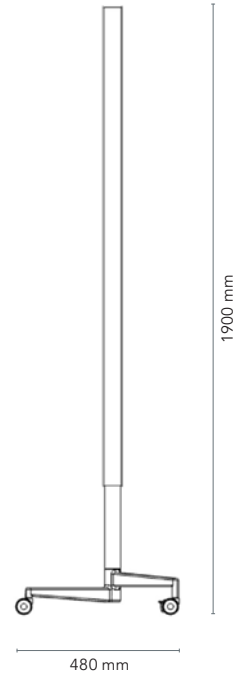
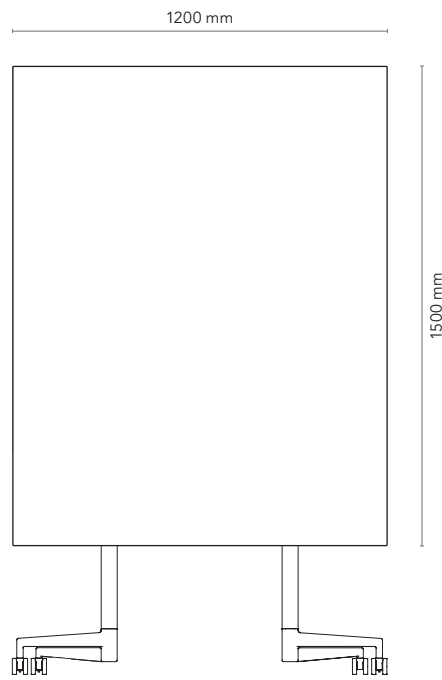

Dynamic

Created by Claus Jakobsen, CHAT BOARD® Dynamic bridges the gap between essential workspace fittings and full-fledged furniture in an ingenious framework design, developed to provide flexible, free-flowing, and multifunctional dimensions to professional, educational, and creative spaces.

Timeless and adaptable by nature, Dynamic was built to accommodate a working world of a digital age, but it was shaped by a profound appreciation of the fundamentally human need to express itself through analogue means.

The Dynamic collection carefully translates two key design themes into a broad selection of self-contained units, each offering different functions that allow it to stand proudly and purposefully on its own, or to partner up with one or more companions to sculpt and define changeable spaces within spaces.

Inviting architects and space planners to create individual and bespoke solutions, Dynamic offers a wide range of combinations, spanning across a variety of materials, finish textures and colour options.

Dynamic content

DYNAMIC WOOD ACOUSTIC:	58
Full Coverage Basic	59
Full Coverage Double ^{NEW}	61
Full Coverage LCD	63
Shelf & Botanic	65
Colours & Materials.....	67
DYNAMIC FABRIC ACOUSTIC:	68
Full Coverage.....	69
Shelf & Botanic	71
Colours & Materials.....	73

Dynamic Wood Acoustic

CHAT BOARD® Dynamic Wood Acoustic combines the noble elegance of carefully composed wood slat surfaces with the soft efficiency of acoustic felt, exquisitely contrasting the smoothness of our signature glass boards.

Dynamic Wood Acoustic offers two base options, Full Coverage and Shelf & Botanic, each presenting a selection of sub-variants. Full Coverage units deliver full-scale, mobile room dividing performance, while Shelf & Botanic units ingeniously combine the agile flexibility of a movable partition wall with either built-in storage or plant boxes.



Materials and facts:

- Frames and slats are manufactured from solid, matt lacquered wood.
- The acoustic felt, used between slats and for the LCD screen panel, is a 9 mm 100% recyclable PET felt. The felt is tested in accordance with EN ISO 354 with a sound absorption coefficient (NRC) of 0.75.
- Aluminium parts (feet, shelves, supports and bookends) are powder coated in Signal White (RAL 9003) or Jet Black (RAL 9005).
- The Dynamic Wood Acoustic units are made easily mobile by the Ø75 mm soft brake casters, matched to your choice of wood/felt combination.
- Glass boards are made with 4 mm tempered safety glass, in accordance with the highest quality standards, finished with smooth C-edges and 4 mm radius corners. Choose between a glossy Classic and a velvety Matt finish as well as a palette of 25 standard glass colours. In addition, the glass can also be made to order in bespoke standard RAL or NCS colours, available for glass.
- BuzziFelt pinboards are made with 6 mm 100% recycled PET felt, available in 3 standard colours.

Please contact our head office with any special requests: info@chat-board.dk



Dynamic Wood Acoustic Full Coverage Basic

Item no.	Description	Colours	Dimensions	Weight
1				(total)
FRAME & FITTINGS - choose a wood finish w. matching fittings			W x H (x D) mm	kg
DYNFCFRAQ-WS	Dynamic Wood Acoustic Full Coverage Basic solid wood frame in white pigmented spruce <i>incl.</i> - wood slats in white pigmented spruce w. sound dampening PET felt in soft white - aluminium feet - powder coated - 4 soft brake casters	white spruce white spruce soft white white white/grey	1290 x 1890 x 120 1225 x 176 (front) 1225 x 1738 (back) 38 x 40 x 420 Ø 75	48.0
				
DYNFCFRAQ-OAK	Dynamic Wood Acoustic Full Coverage Basic solid wood frame in matt lacquered oak <i>incl.</i> - wood slats in matt lacquered oak w. sound dampening PET felt in black - aluminium feet - powder coated - 4 soft brake casters	oak oak black black black/black	1290 x 1890 x 120 1225 x 176 (front) 1225 x 1738 (back) 38 x 40 x 420 Ø 75	48.0
				
DYNFCFRAQ-BO	Dynamic Wood Acoustic Full Coverage Basic solid wood frame in black matt lacquered oak <i>incl.</i> - wood slats in black matt lacquered oak w. sound dampening PET felt in black - aluminium feet - powder coated - 4 soft brake casters	black oak black oak black black black/black	1290 x 1890 x 120 1225 x 176 (front) 1225 x 1738 (back) 38 x 40 x 420 Ø 75	48.0
				

2				
BOARD - add a board in the surface and colour of your choice			W x H mm	kg
Classic				
MT120150	Classic magnetic glass board		1200 x 1500	31.0
Matt				
MTM120150	Matt magnetic glass board		1200 x 1500	31.0
BuzziFelt				
MTBUZZI120150	BuzziFelt magnetic, felt-covered pin board		1200 x 1500	11.4

Add accessories with a Basic Kit
(only available for purchase with a main CHAT BOARD® product):

KITBLACK	Basic kit Black	1 Black Marker Pen, 3 Chrome Magnets
KITWHITE	Basic kit White	1 White Neon Marker Pen, 3 Chrome Magnets
KITBUZZI	Basic kit BuzziFelt	3 Chrome Magnets

Go to page 67 for all colour & material options

[return to index](#)

Dynamic Wood Acoustic Full Coverage Basic

Dimensions & specifications

Front

top: glass-/felt board of choice

bottom: panel w. wood slats & PET felt

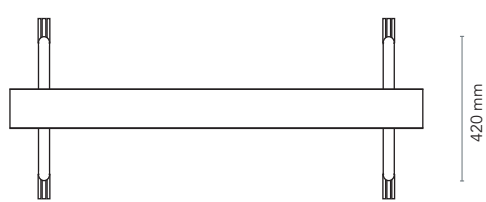
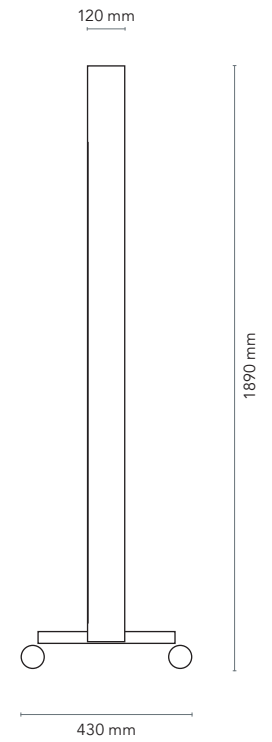
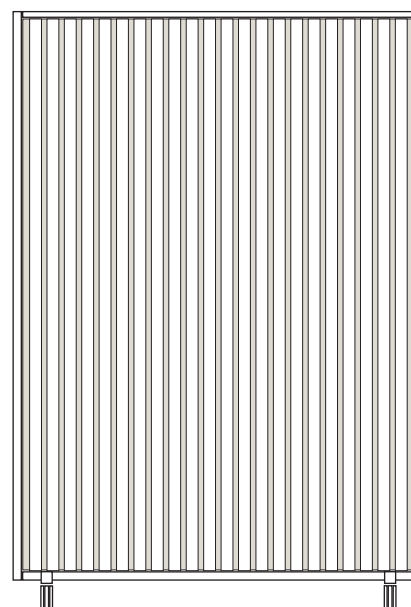
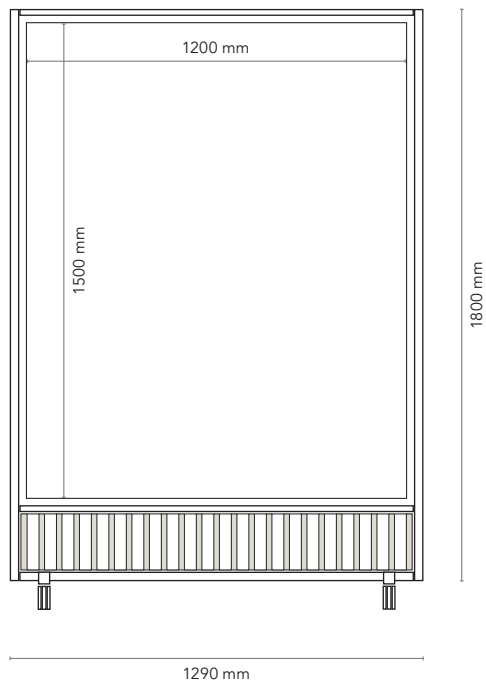

Back

full height: panel w. wood slats & PET felt



[return to index](#)

Dynamic Wood Acoustic Full Coverage Double ^{NEW}

Item no.	Description	Colours	Dimensions	Weight
				(total)
① FRAME & FITTINGS - choose a wood finish w. matching fittings			W x H (x D) mm	kg
DYNFCFRAQ-2-WS	Dynamic Wood Acoustic Full Coverage Double solid wood frame in white pigmented spruce <i>incl.</i> - wood slats in white pigmented spruce w. sound dampening PET felt in soft white - aluminium feet - powder coated - 4 soft brake casters	white spruce white spruce soft white white white/grey	1290 x 1890 x 120 1225 x 176 (front) 1225 x 176 (back) 38 x 40 x 420 Ø 75	39.5
				
DYNFCFRAQ-2-OAK	Dynamic Wood Acoustic Full Coverage Double solid wood frame in matt lacquered oak <i>incl.</i> - wood slats in matt lacquered oak w. sound dampening PET felt in black - aluminium feet - powder coated - 4 soft brake casters	oak oak black black black/black	1290 x 1890 x 120 1225 x 176 (front) 1225 x 176 (back) 38 x 40 x 420 Ø 75	39.5
				
DYNFCFRAQ-2-BO	Dynamic Wood Acoustic Full Coverage Double solid wood frame in black matt lacquered oak <i>incl.</i> - wood slats in black matt lacquered oak w. sound dampening PET felt in black - aluminium feet - powder coated - 4 soft brake casters	black oak black oak black black black/black	1290 x 1890 x 120 1225 x 176 (front) 1225 x 176 (back) 38 x 40 x 420 Ø 75	39.5
				

				(per board)
② BOARDS - add <u>two</u> boards in the surface(s) and colour(s) of your choice (the two boards may be mixed as desired)			kg	
Classic				
MT120150	Classic magnetic glass board		1200 x 1500	31.0
Matt				
MTM120150	Matt magnetic glass board		1200 x 1500	31.0
BuzziFelt				
MTBUZZI120150	BuzziFelt magnetic, felt-covered pin board		1200 x 1500	11.4

Add accessories with a Basic Kit (only available for purchase with a main CHAT BOARD® product):

KITBLACK	Basic kit Black	1 Black Marker Pen, 3 Chrome Magnets
KITWHITE	Basic kit White	1 White Neon Marker Pen, 3 Chrome Magnets
KITBUZZI	Basic kit BuzziFelt	3 Chrome Magnets

Go to page 67 for all colour & material options

[return to index](#)

Dynamic Wood Acoustic Full Coverage Double^{NEW}

Dimensions & specifications

Front

top: glass-/felt board of choice

bottom: panel w. wood slats & PET felt

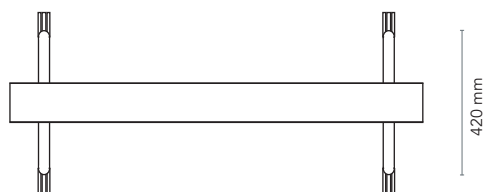
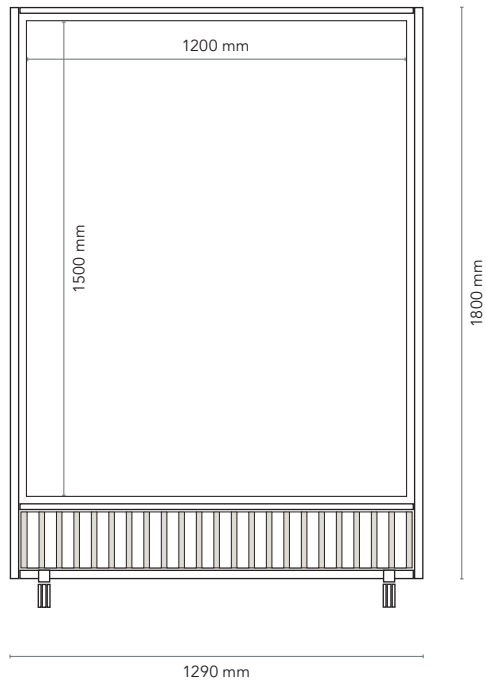

Back

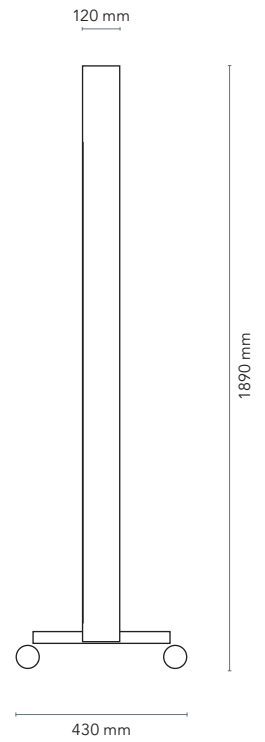

top: glass-/felt board of choice

bottom: panel w. wood slats & PET felt



[return to index](#)

Dynamic Wood Acoustic Full Coverage LCD

Item no.	Description	Colours	Dimensions	Weight
				(total)
① FRAME & FITTINGS - choose a wood finish w. matching fittings			W x H (x D) mm	kg
DYNFCFRAQ-LCD-WS	Dynamic Wood Acoustic Full Coverage LCD solid wood frame in white pigmented spruce <i>incl.</i>	white spruce	1290 x 1890 x 120	41.5
	- wood slats in white pigmented spruce w. sound dampening PET felt in soft white	white spruce soft white	1225 x 176 (front) 1225 x 176 (back)	
	- panel for flat screen installation in sound dampening PET felt in soft white (TV bracked is <u>not</u> included)	soft white	1200 x 1500	
	- aluminium feet - powder coated	white	38 x 40 x 420	
	- 4 soft brake casters	white/grey	Ø 75	
	- cable entry w. cover in white	white	Ø 90	
DYNFCFRAQ-LCD-OAK	Dynamic Wood Acoustic Full Coverage LCD solid wood frame in matt lacquered oak <i>incl.</i>	oak	1290 x 1890 x 120	41.5
	- wood slats in matt lacquered oak w. sound dampening PET felt in black	oak black	1225 x 176 (front) 1225 x 176 (back)	
	- panel for flat screen installation in in sound dampening PET felt in black (TV bracked is <u>not</u> included)	black	1200 x 1500	
	- aluminium feet - powder coated	black	38 x 40 x 420	
	- 4 soft brake casters	black/black	Ø 75	
	- cable entry w. cover in black	black	Ø 90	
DYNFCFRAQ-LCD-BO	Dynamic Wood Acoustic Full Coverage LCD solid wood frame in black matt lacquered oak <i>incl.</i>	black oak	1290 x 1890 x 120	41.5
	- wood slats in black matt lacquered oak w. sound dampening PET felt in black	black oak black	1225 x 176 (front) 1225 x 176 (back)	
	- panel for flat screen installation in in sound dampening PET felt in black (TV bracked is <u>not</u> included)	black	1200 x 1500	
	- aluminium feet - powder coated	black	38 x 40 x 420	
	- 4 soft brake casters	black/black	Ø 75	
	- cable entry w. cover in black	black	Ø 90	
② BOARD - add a board in the surface and colour of your choice			W x H mm	kg
Classic				
MT120150	Classic magnetic glass board		1200 x 1500	31.0
Matt				
MTM120150	Matt magnetic glass board		1200 x 1500	31.0
BuzziFelt				
MTBUZZI120150	BuzziFelt magnetic, felt-covered pin board		1200 x 1500	11.4
Add accessories with a Basic Kit (only available for purchase with a main CHAT BOARD® product):				
KITBLACK	Basic kit Black	1 Black Marker Pen, 3 Chrome Magnets		
KITWHITE	Basic kit White	1 White Neon Marker Pen, 3 Chrome Magnets		
KITBUZZI	Basic kit BuzziFelt	3 Chrome Magnets		

Go to page 67 for all colour & material options

[return to index](#)

Dynamic Wood Acoustic Full Coverage LCD

Dimensions & specifications

Front

- top: glass-/felt board of choice
- bottom: panel w. wood slats & PET felt

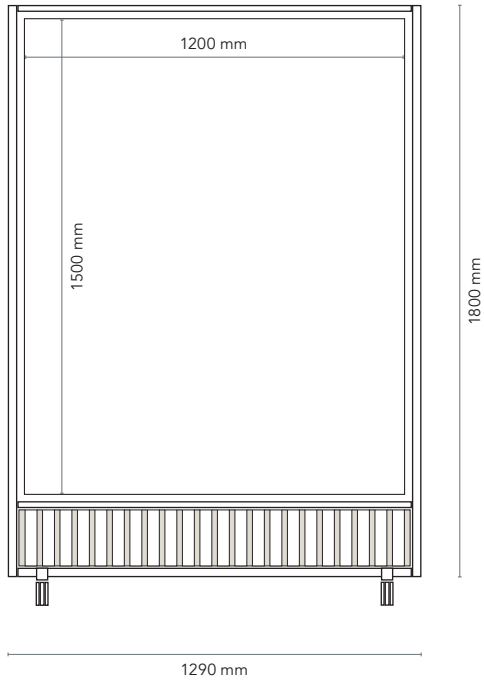

Back

- top: sound dampening PET felt panel for LCD installation
- bottom: panel w. wood slats & PET felt

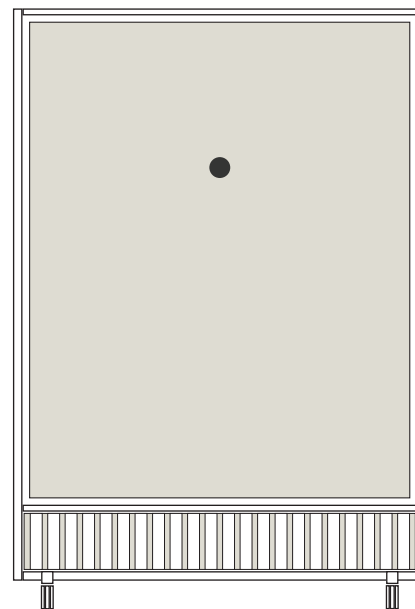

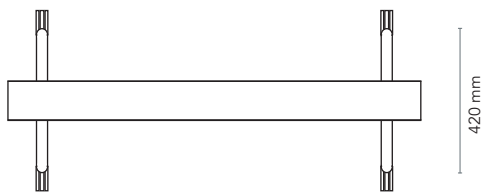
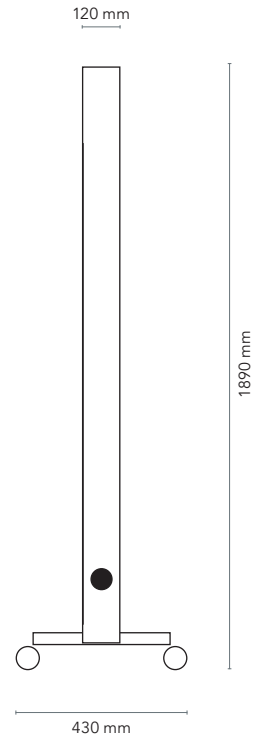

Side

Cable entry at bottom



Dynamic Wood Acoustic Shelf & Botanic

Item no.	Description	Colours	Dimensions	Weight
				(total)
1 FRAME & FITTINGS - choose a wood finish w. matching fittings			W x H (x D) mm	kg
DYNSHFRAQ-WS	Dynamic Wood Acoustic Shelf solid wood frame in white pigmented spruce <i>incl.</i> - wood slats in white pigmented spruce w. sound dampening PET felt in soft white - aluminium feet - powder coated - 4 soft brake casters	white spruce white spruce soft white white white/grey	1290 x 1890 x 120 1225 x 176 (front) 1225 x 176 (back) 38 x 40 x 420 Ø 75	36.5
				
DYNSHFRAQ-OAK	Dynamic Wood Acoustic Shelf solid wood frame in matt lacquered oak <i>incl.</i> - wood slats in matt lacquered oak w. sound dampening PET felt in black - aluminium feet - powder coated - 4 soft brake casters	oak oak black black black/black	1290 x 1890 x 120 1225 x 176 (front) 1225 x 176 (back) 38 x 40 x 420 Ø 75	36.5
				
DYNSHFRAQ-BO	Dynamic Wood Acoustic Shelf solid wood frame in black matt lacquered oak <i>incl.</i> - wood slats in black matt lacquered oak w. sound dampening PET felt in black - aluminium feet - powder coated - 4 soft brake casters	black oak black oak black black black/black	1290 x 1890 x 120 1225 x 176 (front) 1225 x 176 (back) 38 x 40 x 420 Ø 75	36.5
				
				(total)
2 SHELVES / BOTANIC PLANT BOXES - choose either shelves or plant boxes for your frame			W x H x THK mm	kg
Shelves				
DYNSH-W	Dynamic set of 3 shelves	white	580 x 220 x 4	6.0
DYNSH-B	Dynamic set of 3 shelves	black	580 x 220 x 4	6.0
DYNSHBRACKET-W	Dynamic set of 6 shelf support brackets	white		0.5
DYNSHBRACKET-B	Dynamic set of 6 shelf support brackets	black		0.5
Bookends for shelves (optional)			W x H THK mm	kg
DYNSHBE-W	Dynamic set of 3 bookends for shelves	white	140 x 155 x 4	1.2
DYNSHBE-B	Dynamic set of 3 bookends for shelves	black	140 x 155 x 4	1.2
Botanic plant boxes - alternative to shelves (<i>inserts are not included with plant boxes</i>)			W x H x D mm	kg
DYNSHBOT-W	Dynamic Botanic set of 3 plant boxes	white	580 x 140 x 220	12.0
DYNSHBOT-B	Dynamic Botanic set of 3 plant boxes	black	580 x 140 x 220	12.0
				(per board)
3 BOARDS - add two boards in the surface(s) and colour(s) of your choice (the two boards may be mixed as desired)				kg
Classic				
MT60150	Classic magnetic glass board		600 x 1500	16.0
Matt				
MTM60150	Matt magnetic glass board		600 x 1500	16.0
BuzziFelt				
MTBUZZI60150	BuzziFelt magnetic, felt-covered pin board		600 x 1500	5.8
Add accessories with a Basic Kit (only available for purchase with a main CHAT BOARD® product):				
KITBLACK	Basic kit Black	1 Black Marker Pen, 3 Chrome Magnets		
KITWHITE	Basic kit White	1 White Neon Marker Pen, 3 Chrome Magnets		
KITBUZZI	Basic kit BuzziFelt	3 Chrome Magnets		

Go to page 67 for all colour & material options

[return to index](#)

Dynamic Wood Acoustic Shelf & Botanic

Dimensions & specifications

With shelves

top: 3 shelves (bookends optional)
2 glass-/felt boards of choice

bottom: panels w. wood slats & PET felt

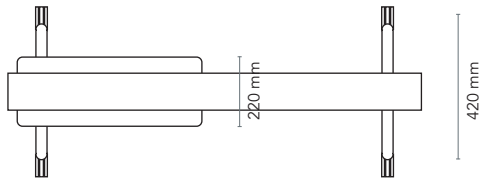
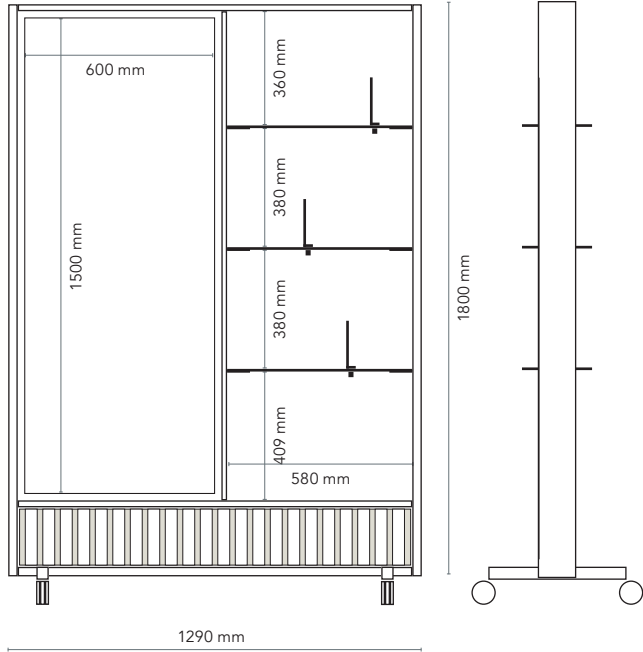

With Botanic plant boxes

top: 3 Botanic plant boxes
2 glass-/felt boards of choice

bottom: panels w. wood slats & PET felt

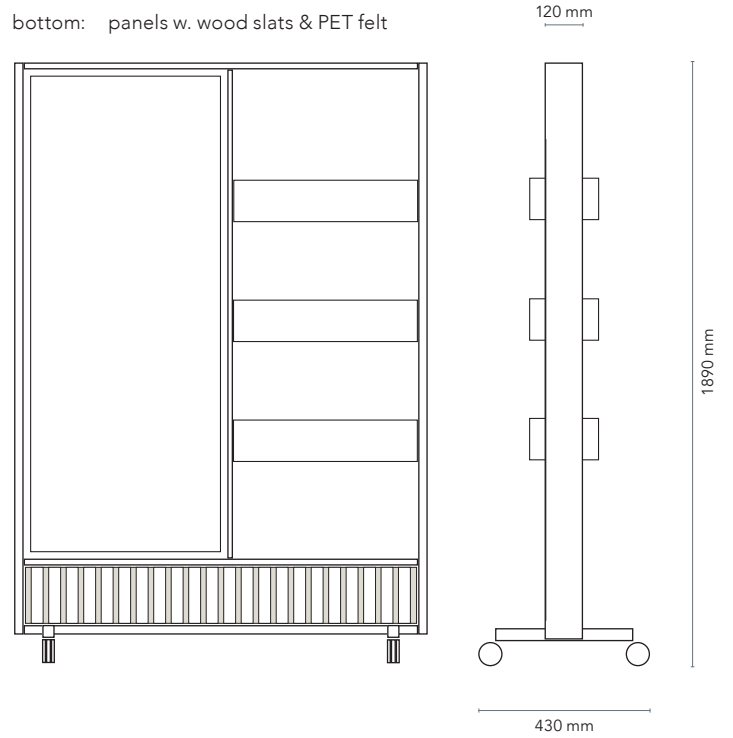

Dynamic Wood Acoustic all

Colours & materials

Frame | wood, PET felt, feet, caster wheels



White spruce



White spruce - soft white
white - white/grey



Oak



Oak - black
black - black/black



Black oak



Black oak - black
black - black/black



Soft white

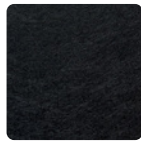

Black



Black

Glass | Classic & Matt boards



Dove MTDO



Grey MTG



Dark Grey MTDG⁽¹⁾



Ink MTINK



Denim MTDE



Lavender MTL



Sky Blue MTSB



Light Blue MTLB



Stone MTSTO



Sand MTSA



Mocca MTM



Black MTS⁽¹⁾



Pine MTP



Army Green MTAG



Khaki MTK



Lily MTL



Nude MTNU



Blush MTBL



Petal MTPE



Plum MTPLU



Ruby MTRU



Red MTR



Orange MTO



Yellow MTY



Pure White MTPW

⁽¹⁾We recommend the Basic Kit White

Felt | BuzziFelt boards



63 Off White



67 Stone Grey



68 Anthracite

[return to index](#)

Dynamic Fabric Acoustic

CHAT BOARD® Dynamic Fabric Acoustic is seriously dedicated to sound reduction, integrating class A acoustic panels, beautifully covered in a choice of sexily sustainable fabrics, thus creating the perfect balance between surface textures.

Dynamic Fabric Acoustic offers two base options, Full Coverage and Shelf & Botanic, each presenting a selection of choices. Full Coverage units deliver full-scale, mobile room dividing- and acoustic performance, while Shelf & Botanic units ingeniously combine the agile flexibility of a movable partition wall with either built-in storage or plant boxes.

Materials and facts:

- Dynamic Fabric Acoustic frames are manufactured from solid, matt lacquered wood.
- The 40 mm acoustic panels are composed of stone wool and covered in a fabric that matches your preferences and desired price category: Quest^{cat1} and Sumi^{cat2} by Camira, Molly^{cat3} and Clara^{cat3} by Kvadrat.
- Aluminium parts (feet, shelves, supports and bookends) are powder coated in Signal White (RAL 9003) or Jet Black (RAL 9005).
- Dynamic Fabric Acoustic gøres både mobil og fleksibel af de Ø75 mm bløde bremsehjul, matchet til dit valg af træramme.
- Glass boards are made with 4 mm tempered safety glass, in accordance with the highest quality standards, finished with smooth C-edges and 4 mm radius corners. Choose between a glossy Classic and a velvety Matt finish as well as a palette of 25 standard glass colours. In addition, the glass can also be made to order in bespoke standard RAL or NCS colours, available for glass.
- BuzziFelt pinboards are made with 6 mm 100% recycled PET felt, available in 3 standard colours.

Please contact our head office with any special requests: info@chat-board.dk



Dynamic Fabric Acoustic Full Coverage

Item no.	Description	Colours	Dimensions	Weight
				(total)
1 FRAME & FITTINGS - choose a wood finish w. matching fittings			W x H (x D) mm	kg
DYNFCFR-WS	Dynamic Fabric Acoustic Full Coverage solid wood frame in white pigmented spruce <i>incl.</i> - aluminium feet - powder coated - 4 soft brake casters	white spruce white white/grey	1290 x 1890 x 120 38 x 40 x 420 Ø 75	33.5
DYNFCFR-OAK	Dynamic Fabric Acoustic Full Coverage solid wood frame in matt lacquered oak <i>incl.</i> - aluminium feet - powder coated - 4 soft brake casters	natural oak black black/black	1290 x 1890 x 120 38 x 40 x 420 Ø 75	33.5
DYNFCFR-BO	Dynamic Fabric Acoustic Full Coverage solid wood frame in black matt lacquered oak <i>incl.</i> - aluminium feet - powder coated - 4 soft brake casters	black oak black black/black	1290 x 1890 x 120 38 x 40 x 420 Ø 75	33.5
				(front / back)
2 ACOUSTIC PANELS (front & back) - choose your fabric type and -colour			W x H x THK mm	kg
DYNFCACU1	Dynamic Fabric Acoustic Full Coverage class A acoustic panels covered in Quest fabric (cat. 1)	Quest by Camira	1225 x 176 x 40 (front) (2x) 612.5 x 1738 x 40 (back)	5.0
DYNFCACU2	Dynamic Fabric Acoustic Full Coverage class A acoustic panels covered in Sumi fabric (cat. 2)	Sumi by Camira	1225 x 176 x 40 (front) (2x) 612.5 x 1738 x 40 (back)	5.0
DYNFCACU3	Dynamic Fabric Acoustic Full Coverage class A acoustic panels covered in Molly or Clara fabric (cat. 3)	Molly / Clara by Kvadrat	1225 x 176 x 40 (front) (2x) 612.5 x 1738 x 40 (back)	5.0
				(total)
3 BOARD - add a board in the surface and colour of your choice			W x H mm	kg
Classic				
MT120150	Classic magnetic glass board		1200 x 1500	31.0
Matt				
MTM120150	Matt magnetic glass board		1200 x 1500	31.0
BuzziFelt				
MTBUZZI120150	BuzziFelt magnetic, felt-covered pin board		1200 x 1500	11.4
Add accessories with a Basic Kit (only available for purchase with a main CHAT BOARD® product):				
KITBLACK	Basic kit Black	1 Black Marker Pen, 3 Chrome Magnets		
KITWHITE	Basic kit White	1 White Neon Marker Pen, 3 Chrome Magnets		
KITBUZZI	Basic kit BuzziFelt	3 Chrome Magnets		

Go to page 73 for all colour & material options

[return to index](#)

Dynamic Fabric Acoustic Full Coverage

Dimensions & specifications

Front

top: glass-/felt board of choice

bottom: fabric covered acoustic panel

Back

full height: fabric covered acoustic panels

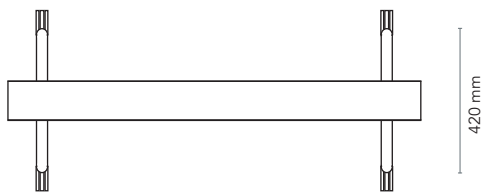
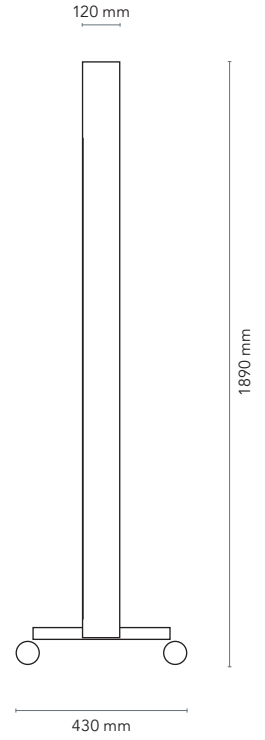
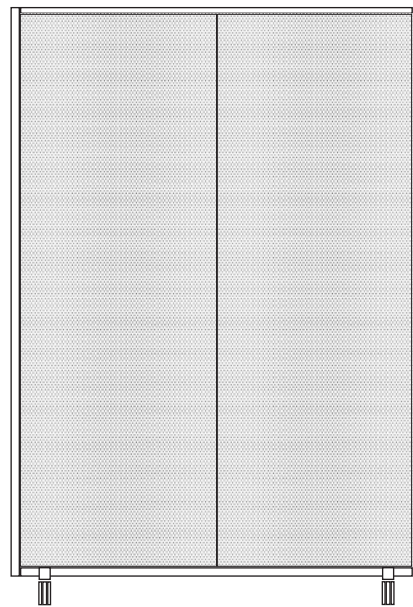
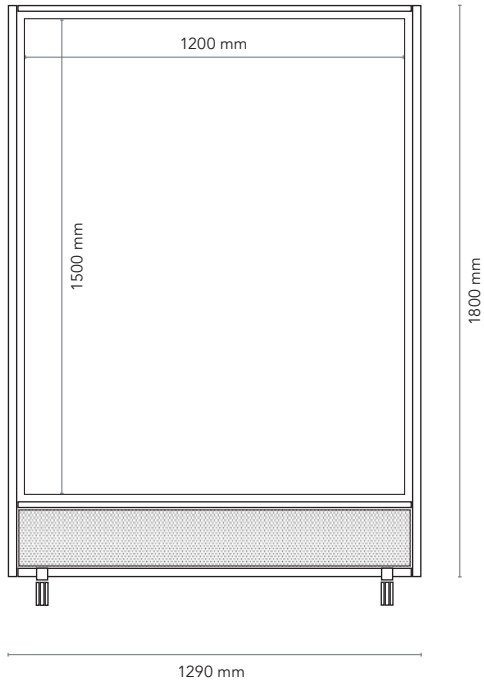

Dynamic Fabric Acoustic Shelf & Botanic

Item no.	Description	Colours	Dimensions	Weight
				(total)
1 FRAME & FITTINGS - choose a wood finish w. matching fittings			W x H (x D) mm	kg
DYNSHFR-WS	Dynamic Fabric Acoustic Shelf solid wood frame in white pigmented spruce <i>incl.</i> - aluminium feet - powder coated - 4 soft brake casters	white spruce white white/grey	1290 x 1890 x 120 38 x 40 x 420 Ø 75	33.5
DYNSHFR-OAK	Dynamic Fabric Acoustic Shelf solid wood frame in matt lacquered oak <i>incl.</i> - aluminium feet - powder coated - 4 soft brake casters	natural oak black black/black	1290 x 1890 x 120 38 x 40 x 420 Ø 75	33.5
DYNSHFR-BO	Dynamic Fabric Acoustic Shelf solid wood frame in black matt lacquered oak <i>incl.</i> - aluminium feet - powder coated - 4 soft brake casters	black oak black black/black	1290 x 1890 x 120 38 x 40 x 420 Ø 75	33.5
				(total)
2 ACOUSTIC PANELS (front & back) - choose your fabric type and -colour			(front / back)	(total)
		Fabric	W x H x THK mm	kg
DYNSHACU1	Dynamic Fabric Acoustic Shelf class A acoustic panels covered in Quest fabric (cat. 1)	Quest by Camira	1225 x 176 x 40 (front) 1225 x 176 x 40 (back)	2.0
DYNSHACU2	Dynamic Fabric Acoustic Shelf class A acoustic panels covered in Sumi fabric (cat. 2)	Sumi by Camira	1225 x 176 x 40 (front) 1225 x 176 x 40 (back)	2.0
DYNSHACU3	Dynamic Fabric Acoustic Shelf class A acoustic panels covered in Molly or Clara fabric (cat. 3)	Molly / Clara by Kvadrat	1225 x 176 x 40 (front) 1225 x 176 x 40 (back)	2.0
				(total)
3 SHELVES / BOTANIC PLANT BOXES - choose either shelves or plant boxes for your frame			W x H x THK mm	kg
Shelves				
DYNSH-W	Dynamic set of 3 shelves	white	580 x 220 x 4	6.0
DYNSH-B	Dynamic set of 3 shelves	black	580 x 220 x 4	6.0
DYNSHBRACKET-W	Dynamic set of 6 shelf support brackets	white		0.5
DYNSHBRACKET-B	Dynamic set of 6 shelf support brackets	black		0.5
Bookends for shelves (optional)			W x H x THK mm	kg
DYNSHBE-W	Dynamic set of 3 bookends for shelves	white	140 x 155 x 4	1.2
DYNSHBE-B	Dynamic set of 3 bookends for shelves	black	140 x 155 x 4	1.2
Botanic plant boxes - alternative to shelves (<i>inserts are <u>not</u> included with plant boxes</i>)			W x H x D mm	kg
DYNSHBOT-W	Dynamic Botanic set of 3 plant boxes	white	580 x 140 x 220	12.0
DYNSHBOT-B	Dynamic Botanic set of 3 plant boxes	black	580 x 140 x 220	12.0
				(per board)
4 BOARDS - add <u>two</u> boards in the surface(s) and colour(s) of your choice (the two boards may be mixed as desired)				kg
Classic				
MT60150	Classic magnetic glass board		600 x 1500	16.0
Matt				
MTM60150	Matt magnetic glass board		600 x 1500	16.0
BuzziFelt				
MTBUZZI60150	BuzziFelt magnetic, felt-covered pin board		600 x 1500	5.8
Add accessories with a Basic Kit (only available for purchase with a main CHAT BOARD® product):				
KITBLACK	Basic kit Black	1 Black Marker Pen, 3 Chrome Magnets		
KITWHITE	Basic kit White	1 White Neon Marker Pen, 3 Chrome Magnets		
KITBUZZI	Basic kit BuzziFelt	3 Chrome Magnets		

[return to index](#)

Dynamic Fabric Acoustic Shelf & Botanic

Dimensions & specifications

With shelves

top: 3 shelves (bookends optional)
2 glass-/felt boards of choice

bottom: fabric covered acoustic panel

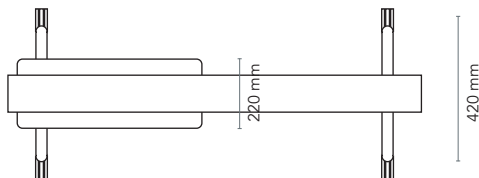
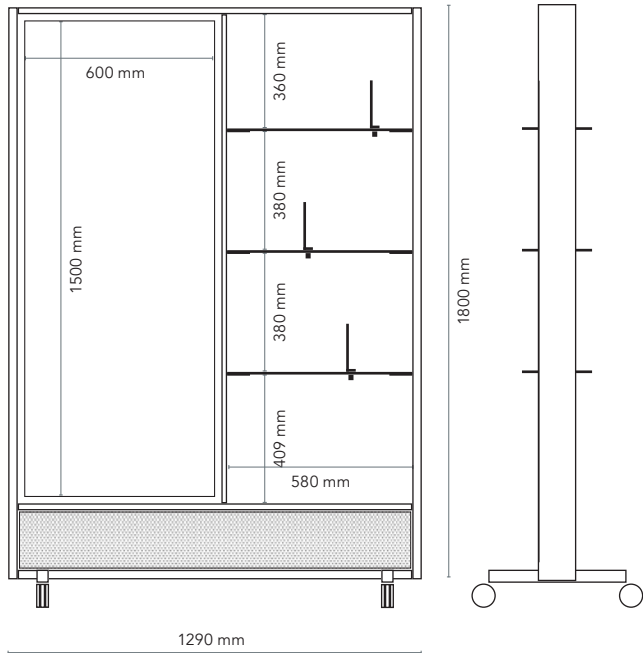

With Botanic plant boxes

top: 3 Botanic plant boxes
2 glass-/felt boards of choice

bottom: fabric covered acoustic panel

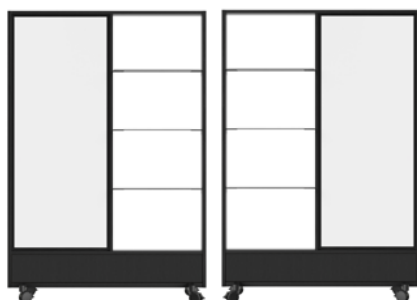
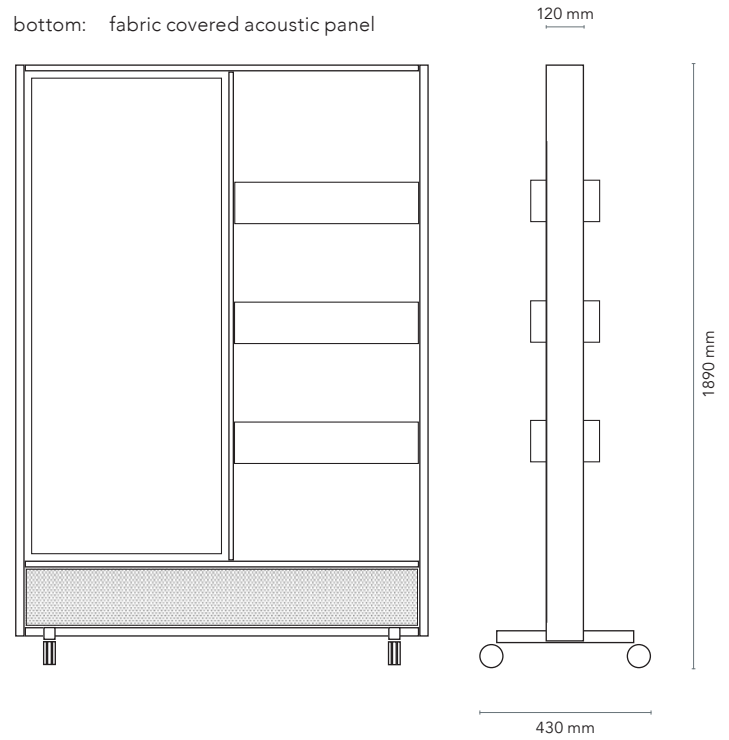

Dynamic Fabric Acoustic all

Colours & materials

Frame | wood, feet, caster wheels

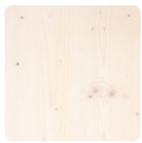

White spruce



White - white/grey



Oak



Black - black/black



Black oak



Black - black/black

Fabric



Barnacle QUE03

Category 1

Quest by Camira
100% post-consumer recycled polyester incl. 75% SEAQUAL yarn



Tang SUR01

Category 2

Sumi by Camira
90% wool, 10% polyamide

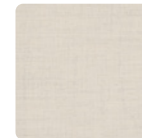

Molly 0110

Category 3

Molly by Kvadrat
100% new wool worsted



Quartz QUE05



Pebble QUE27



Tokyo SUR02



Kobe SUR03



Clara 0188

Clara by Kvadrat
92% new wool worsted, 8% nylon

Glass | Classic & Matt boards



Dove MTDO



Grey MTG



Dark Grey MTDG⁽¹⁾



Ink MTINK



Denim MTDE



Lavender MTL



Sky Blue MTSB

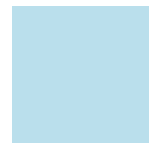

Light Blue MTLB



Stone MTSTO



Sand MTSA



Mocca MTM



Black MTS⁽¹⁾



Pine MTPi



Army Green MTAG



Khaki MTK



Lily MTLi



Nude MTNU



Blush MTBL



Petal MTPE



Plum MTPLU



Ruby MTRU



Red MTR



Orange MTO



Yellow MTY



Pure White MTPW

⁽¹⁾we recommend the Basic Kit White

Felt | BuzziFelt boards



63 Off White



67 Stone Grey



68 Anthracite

[return to index](#)

ACCESSORIES

functional finishing touches

DISCØ

The CHAT BOARD® DISCØ [di-skow] collection is a fresh and slightly flirtatious take on the quintessential glass board accessories. Sculpted for the human hand, the reassuring warmth of the softly shaped wooden discs puts the pleasure back into erasing and adhering, all with a playful twist.

The conveniently magnetic DISCØ eraser effortlessly carries a CHAT BOARD® marker in its embrace and comes with an elegant entourage of five accompanying DISCØ magnets, mirroring the same, understated, yet undeniably cool design.

Get carried away by the new DISCØ fever and let those groovy moves slide over your CHAT BOARD® product of choice without regret.

DISCØ is crafted from solid oak, and it is available in natural and black, both with a touchable matt lacquered finish.

We recommend getting perfectly warmed up with the essential DISCØ set of 1 eraser, 5 magnets and 1 black marker pen.

Both are also available for purchase individually, and the magnets in sets of 10 pieces.



DISCØ

Item no.	Description	Dimensions	Weight
 Natural oak Ø x D mm kg			
DISCØSET-O	DISCØ Set in oak - matt lacquered	1 Eraser ^A , 5 Magnets, 1 Black Marker Pen	0.220
DISCØERS-O	DISCØ Eraser in oak - matt lacquered	1 Eraser ^A	80 x 24
DISCØMAG-O	DISCØ Magnet in oak - matt lacquered	1 Magnet	19 x 24
DISCØMAG10-O	DISCØ Magnet Set in oak - matt lacquered	10 Magnets	0.200

 Black oak Ø x D mm kg			
DISCØSET-B	DISCØ Set in oak - matt, black lacquered	1 Eraser ^A , 5 Magnets, 1 Black Marker Pen	0.220
DISCØERS-B	DISCØ Eraser in oak - matt, black lacquered	1 Eraser ^A	80 x 24
DISCØMAG-B	DISCØ Magnet in oak - matt, black lacquered	1 Magnet	19 x 24
DISCØMAG10-B	DISCØ Magnet Set in oak - matt, black lacquered	10 Magnets	0.200

NB Only dry-erase markers will fit in the Eraser. It is not suitable for holding a neon pen

^A2 extra felt eraser pads included

Wood



Oak
matt lacquered



Black oak
matt, black lacquered

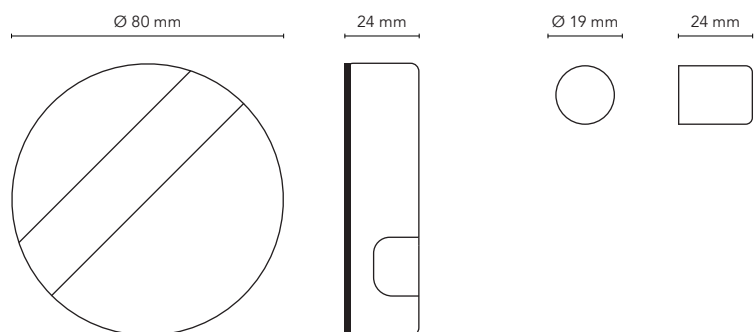



Classic Crafted Keeper

Complete your CHAT BOARD® product with the Classic Crafted Keeper, a magnetic pen holder exquisitely shaped in oak veneer. Fully flexible and easily attached and detached, it can be placed on any magnetic CHAT BOARD® surface and moved around according to mood and circumstances.

The CHAT BOARD® Classic Crafted Keeper is crafted from oak veneer, treated with a matt PU lacquer.



Classic Crafted Keeper

Item no.	Description	Dimensions	Weight
	Oak veneer	W x H x D mm	kg
MTCROKE	Classic Crafted Keeper magnetic pen holder in matt lacquered oak veneer	100 x 100 x 70	0.3
	Black oak veneer	W x H x D mm	kg
MTCRBKE	Classic Crafted Keeper magnetic pen holder in black, matt lacquered oak veneer	100 x 100 x 70	0.3

Wood veneer



Oak
matt lacquered



Black oak
matt, black lacquered

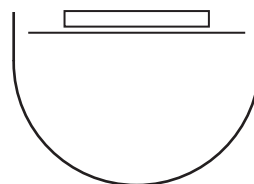
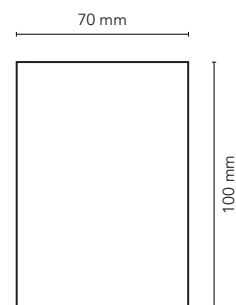
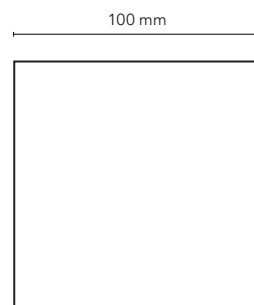

Storage Unit



CHAT BOARD® Storage Unit, in a timeless and sleek design by ARDE design studio, is a functional two-compartment storage unit for all of your CHAT BOARD® accessories. Available in 2 different versions, one to perfectly complement any of our boards, it offers the perfect solution for organising and keeping track of pens, erasers and extra magnets.

CHAT BOARD® Storage Unit is made of injection moulded ABS and powder coated steel, making it durable as well as functional.

It is available in 2 different versions, and in a choice of 2 versatile colours: Signal White (RAL 9003) and Jet Black (RAL 9005).



Storage Unit

Item no.	Description	Dimensions	Weight
			
White		W x H x D mm	kg
SUMAG9003	Storage Unit Magnetic magnetic pen holder - white	205 x 120 x 95	0.5
SUHAN9003	Storage Unit Hanger pen holder with board-/wall picture - white	205 x 125 x 100	0.5
			
Black		W x H x D mm	kg
SUMAG9005	Storage Unit Magnetic magnetic pen holder - black	205 x 120 x 95	0.5
SUHAN9005	Storage Unit Hanger pen holder with board-/wall picture - black	205 x 125 x 100	0.5

ABS & steel



Magnetic

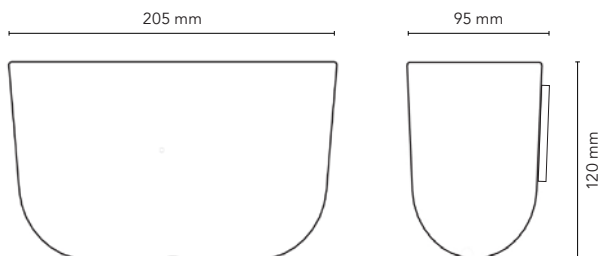

Hanger

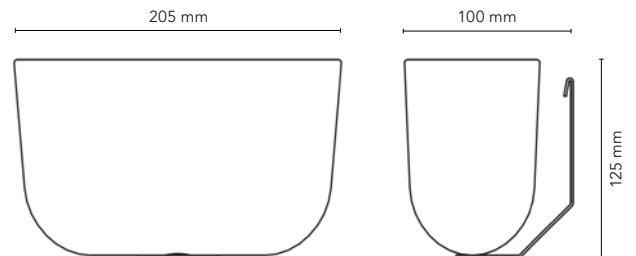









Pens, magnets, cleaners etc.

Item no.	Description		Weight
			kg
CB517BLACK	Black dry erase marker pen 1 pc		0.020
CB517SET4	Dry erase marker pen set - Standard 4 pcs: black / red / blue / green		0.080
CB517SET4MATT	Dry erase marker pen set - Matt 4 pcs: black / black / blue / green		0.080
CBNEONW01	White neon marker pen 1 pc		0.020
CBNEON041	Neon marker pen set I 4 pcs: blue / green / yellow / white		0.080
CBNEON042	Neon marker pen set II 4 pcs: pink / purple / orange / white		0.080
MAG161210	Chrome magnet 10 pcs		0.160
MAGBLACK161210 ^{NEW}	Black magnet - chrome magnet with black plastic cover 10 pcs		0.160
MTERS	Eraser magnetic cleaning sponge		0.020
CBOWMAG	Woody Magnet with wooden cover in natural oak 1 pc		0.021
CBOWMAG10	Woody Magnet with wooden cover in natural oak 10 pcs		0.210
CBBWMAG	Woody Magnet with wooden cover in black oak 1 pc		0.021
CBBWMAG10	Woody Magnet with wooden cover in black oak 10 pcs		0.210
CBOWERS	Woody Eraser in natural oak incl. 2 extra felt eraser pads		0.205
CBBWERS	Woody Eraser in black oak incl. 2 extra felt eraser pads		0.205
CBFIBRE	Woody felt eraser pads (extra) 5 pcs		0.020
CBCLEANER	Cleaner glass cleaning liquid 110 ml bottle		0.120
CBMICROFIBERSET	Microfibre cleaning cloths 5 pcs		0.200





[return to index](#)

Starter sets I/II

Item no.	Description	Weight
Basic starter sets		
CBSTARTSET	Starter Set - Standard incl. 1 Eraser, 1 Cleaner, 5 chrome magnets, 4 dry erase marker pens: black / red / blue / green	0.350 kg
		
CBSTARTSET MATT	Starter Set - Matt incl. 1 Eraser, 1 Cleaner, 5 chrome magnets, 4 dry erase marker pens: black / black / blue / green	0.350
		
CBSTARTSET01	Starter Set - Neon I incl. 1 Eraser, 1 Cleaner, 5 chrome magnets, 4 neon marker pens: blue / green / yellow / white	0.350
		
CBSTARTSET02	Starter Set - Neon II incl. 1 Eraser, 1 Cleaner, 5 chrome magnets, 4 neon marker pens: pink / purple / orange / white	0.350
		
Woody starter sets - natural oak		
CBSARTSETOW517	Woody Starter Set Natural - Standard incl. 1 Woody Eraser, 1 Cleaner, 5 Woody Magnets, 4 dry erase marker pens: black / red / blue / green	0.560 kg
		
CBSTARTSETOW517 MATT	Woody Starter Set Natural - Matt incl. 1 Woody Eraser, 1 Cleaner, 5 Woody Magnets, 4 dry erase marker pens: black / black / blue / green	0.560
		
CBSTARTSETOW01	Woody Starter Set Natural - Neon I incl. 1 Woody Eraser, 1 Cleaner, 5 Woody Magnets, 4 neon marker pens: blue / green / yellow / white	0.560
		
CBSTARTSETOW02	Woody Starter Set Natural - Neon II incl. 1 Woody Eraser, 1 Cleaner, 5 Woody Magnets, 4 neon marker pens: pink / purple / orange / white	0.560
		

[return to index](#)

Starter sets II/II

Item no.	Description	Weight
Woody starter sets - black oak		
CBSTARTSETBW517	Woody Starter Set Black - Standard incl. 1 Woody Eraser, 1 Cleaner, 5 Woody Magnets, 4 dry erase marker pens: black / red / blue / green	0.560
		
CBSTARTSETBW517 MATT	Woody Starter Set Black I - Matt incl. 1 Woody Eraser, 1 Cleaner, 5 Woody Magnets, 4 dry erase marker pens: black / black / blue / green	0.560
		
CBSTARTSETBW01	Woody Starter Set Black - Neon I incl. 1 Woody Eraser, 1 Cleaner, 5 Woody Magnets, 4 neon marker pens: blue / green / yellow / white	0.560
		
CBSTARTSETBW02	Woody Starter Set Black - Neon II incl. 1 Woody Eraser, 1 Cleaner, 5 Woody Magnets, 4 neon marker pens: pink / purple / orange / white	0.560
		

Pen trays

Item no.	Description	Weight
Acrylic		
PB15W	Pen tray 15 - white acrylic L 150 mm	0.030
		
PB15	Pen tray 15 - clear acrylic L 150 mm	0.030
		
PB30W	Pen tray 30 - white acrylic L 300 mm	0.060
		
PB30	Pen tray 30 - clear acrylic L 300 mm	0.060
		
Powder coated aluminium (Signal White RAL 9003)		
PB690HAN	Pen tray 69 - powder coated aluminium L 690 mm With bend - to be mounted onto the back of the steel frame Matches wall-mounted boards: 69.5 x 69.5 cm, 70 x 90 cm (vertical)	0.280
		
PB890HAN	Pen tray 89 - powder coated aluminium L 890 mm With bend - to be mounted onto the back of the steel frame Matches wall-mounted boards: 70 x 90 cm (horizontal), 90 x 120 cm (vertical)	0.360
		
PB990HAN	Pen tray 99 - powder coated aluminium L 990 mm With bend - to be mounted onto the back of the steel frame Matches wall-mounted boards: 100 x 100 cm, 100 x 150 cm (vertical), 100 x 200 cm (vertical)	0.410
		
PB1190HAN	Pen tray 119 - powder coated aluminium L 1190 mm With bend - to be mounted onto the back of the steel frame Matches wall-mounted boards: 90 x 120 cm (horizontal), 120 x 120 cm, 120 x 150 cm (vertical), 120 x 200 cm (vertical), 120 x 240 cm (vertical)	0.490
		
PB1490HAN	Pen tray 149 - powder coated aluminium L 1490 mm With bend - to be mounted onto the back of the steel frame Matches wall-mounted boards: 100 x 150 cm (horizontal), 120 x 150 cm (horizontal)	0.610
		
PB1990HAN	Pen tray 199 - powder coated aluminium L 1990 mm With bend - to be mounted onto the back of the steel frame Matches wall-mounted boards: 100 x 200 cm (horizontal), 120 x 200 cm (horizontal)	0.820
		
PB2390HAN	Pen tray 239 - powder coated aluminium L 2390 mm With bend - to be mounted onto the back of the steel frame Matches wall-mounted board: 120 x 240 cm (horizontal)	0.980
		

[return to index](#)

Miscellaneous accessories & spare parts

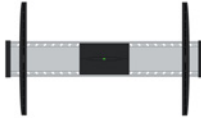
Item no.	Description	Weight
Miscellaneous accessories		
CBTVBR	TV bracket for mounting on the back of Mobile Conference	3.00 kg
		
Spare parts (extra)		
MAGROUND - SMALL	Mounting Magnet Set - small 2 mounting magnets, incl. washers	for wall-mounted boards, sizes (cm): 40 x 50 to 69.5 x 69.5
MAGROUND - BIG	Mounting Magnet Set - big 2 mounting magnets, incl. washers	for wall-mounted boards, sizes (cm): 70 x 90 to 120 x 240
METALTRACK4050	Hanging rail L 350 mm	for wall-mounted boards, sizes (cm): 40 x 50
METALTRACK5080	Hanging rail L 450 mm	for wall-mounted boards, sizes (cm): 50 x 80, 58.5 x 120*, 60 x 150* (*vertically mounted)
METALTRACK7090	Hanging rail L 650 mm	for wall-mounted boards, sizes (cm): 69.5 x 69.5, 70 x 90
METALTRACK100100	Hanging rail L 850 mm	for wall-mounted boards, sizes (cm): 90 x 120, 58.5 x 120, 100 x 100, 100 x 120, 120 x 120, 100 x 150*, 120 x 150*, 100 x 200*, 120 x 200* (*vertically mounted)
METALTRACK120120	Hanging rail L 1100 mm NB when ordered separately (and shipped with a courier service), this will be split into smaller lengths	for wall-mounted boards, size (cm): 100 x 150, 120 x 150, 120 x 200*, 120 x 240*, 122 x 244* (*vertically mounted)
METALTRACK120200	Hanging rail L 1900 mm NB when ordered separately (and shipped with a courier service), this will be split into smaller lengths	for wall-mounted boards, sizes (cm): 100 x 200, 120 x 200, 120 x 240, 122 x 244



USEFUL INFORMATION

Maintenance

Your CHAT BOARD® product requires minimal daily maintenance and by following these simple guidelines, it will look beautiful for years to come:

Glass

As a rule, we recommend cleaning the board using a CHAT BOARD® Eraser or a soft cloth, depending on how much writing/illustration needs to be removed.

Next, polish the glass with the CHAT BOARD® Cleaner, a window cleaning spray or regular rubbing alcohol.

NB

Never spray Cleaner directly on the writing/illustration as this will prolong the cleaning process, and make sure you always use a soft material such as paper towel - or our favourite: a microfibre cloth.

In case someone has accidentally used permanent marker on the glass, this can be removed with rubbing alcohol, after which the board will be ready to use as normal.

Kvadrat fabrics

Remix Screen, Relate Screen, Molly, Clara:

Vacuum regularly. Professional dry cleaning with tetrachloroethylene, normal process.

Camira fabrics

Quest:

Vacuum regularly. Wipe with a damp cloth using a proprietary upholstery shampoo/soap. For deeper cleaning use steam, bleach, alcohol or professionally dry clean.

Sumi:

Vacuum regularly. Wipe with a damp cloth using soap and water or use proprietary upholstery shampoo. For deeper cleaning use steam or professionally dry clean.

BuzziFelt

Vacuum clean regularly. Do not wash. Do not remove the BuzziFelt from the product. Treat spillages immediately. Professional dry clean or wipe clean with a pH neutral soap and a damp cloth.

General information

Warranty

CB provides a five-year warranty on standard products against defects in materials and workmanship. The warranty does not extend to ordinary wear and tear.

Tolerances & variations in colour or nuance

Please note that minor scratches found on the back or front of the products are not considered as defects. Likewise, small and insignificant air bubbles or production related discrepancies in colour or nuance in the glass of different items are not considered as defects. Please note that such occurrences are due to normal manufacturing circumstances.



A modern dining table and chairs set in a minimalist room. The table is made of light-colored wood with thick, tapered legs. The chairs have a yellow perforated metal backrest and a wooden seat. A black adjustable lamp hangs over the table. The room has a concrete wall and a large window that looks out onto a tree. The floor is a light-colored concrete.

designed & manufactured by
CHAT BOARD A/S

Tempovej 10 C
DK-2750 Ballerup
Denmark

+45 4484 5144
info@chat-board.dk
www.chat-board.dk

VAT no. DK 15806230

