

CHAT BOARD

collection

2023

EN



introduction

The original and first of its kind, the CHAT BOARD® magnetic glass board saw the light of day in 2003 as the joint invention of glass specialist Hans Henning Jensen and his hotelier daughter, Josefine Honoré.

The deceptively simple product was conceived from a wish to elevate the conventional noticeboard to a higher aesthetic level, and to encourage and strengthen visual communication. Not only did it set a new industry standard as the first-ever floating, magnetic glass board with no visible hardware, it really came to inspire the use of coloured glass surfaces as a powerful interior design feature.

Since then, both company and collection have grown and diversified significantly, and the portfolio now comprises a wide and continuously expanding range of mutually complementing products, preferred by clients across the globe.

CHAT BOARD remains in family hands, proudly continuing the journey that was begun two decades ago.

Deeply rooted in the Scandinavian design tradition, a CHAT BOARD product embodies an uncompromising commitment to quality in design, materials, and craftsmanship.

We collaborate closely with leading designers on developing beautiful, functional, and innovative designs, all carefully created to enhance and nurture creative dialogue between people in both professional and domestic settings.

Every piece in the collection is handmade and quality-controlled at our factory just outside Copenhagen, while raw materials are sourced from a few handpicked suppliers, locally and in the EU. Besides giving us complete control of our supply chain, this helps to ensure the unrivalled and consistent quality of our products, while allowing us to keep lead times at a highly competitive level, even for custom made solutions.



content

WALL

Classic.....	6
Classic Surfacing ^{NEW}	9
Classic Crafted.....	11
Matt.....	14
Matt Surfacing ^{NEW}	17
Elements.....	19
Elements Surfacing ^{NEW}	22
Orbit ^{NEW}	24
BuzziFelt.....	27
Planner.....	30

MOBILE BOARDS & FURNISHINGS

SQUAD.....	34
SQUAD Solid.....	37
Mobile.....	40
Move Acoustic.....	43
Dynamic.....	46
Wardrobe.....	66

ACCESSORIES

DISCØ ^{NEW}	70
Classic Crafted Keeper.....	72
Storage Unit.....	74
Essential Accessories.....	76

USEFUL INFORMATION

Maintenance.....	83
------------------	----

WALL

wall-mounted boards

Classic

CHAT BOARD® Classic inspires and facilitates creative dialogue between people and minds. Specially designed to help generate, visualise, organise, and exchange ideas and information, it provides the perfect finishing touch in any office-, meeting- or breakout space.

The design is sleekly elegant and deceptively simple; each element has a clear function, and nothing is superfluous. And the smooth, magnetic glass surface offers the most satisfying writing- and drawing experience you'll ever have. Unrivalled in quality and durability, it comes with the added bonus of being easy to clean, helping to give it its long lifespan and making it the definitive replacement for any whiteboard.

CHAT BOARD® Classic is made with 4 mm tempered safety glass, in accordance with the highest quality standards, finished with smooth C-edges and 4 mm radius corners. It can be mounted both horizontally and vertically on the wall, is easily switched from one orientation to another, and is available in 13 standard sizes and 25 standard colours. In addition, it can be made to order in bespoke sizes, shapes and standard RAL and NCS glass colours.

Please contact our head office with any special requests: info@chat-board.dk

Quality test

Security: EN 14434:2010















Cradle to Cradle Certified™ is a certification mark licensed by the Cradle to Cradle Products Innovation Institute

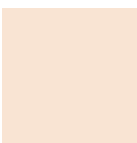

Classic

Item no.	Description	Dimensions		Weight kg
		Horizontally mounted	Vertically mounted	
		W x H mm	W x H mm	
MT5080	Classic magnetic glass board	800 x 500	500 x 800	6.8
MT7070	Classic magnetic glass board	695 x 695	695 x 695	7.8
MT7090	Classic magnetic glass board	900 x 700	700 x 900	11.0
MT58120	Classic magnetic glass board	1200 x 585	585 x 1200	12.5
MT60150 ^{NEW}	Classic magnetic glass board	1500 x 600	600 x 1500	14.4
MT100100	Classic magnetic glass board	1000 x 1000	1000 x 1000	16.0
MT90120	Classic magnetic glass board	1200 x 900	900 x 1200	17.8
MT120120	Classic magnetic glass board	1200 x 1200	1200 x 1200	25.8
MT100150	Classic magnetic glass board	1500 x 1000	1000 x 1500	26.0
MT120150	Classic magnetic glass board	1500 x 1200	1200 x 1500	31.0
MT100200	Classic magnetic glass board	2000 x 1000	1000 x 2000	36.0
MT120200	Classic magnetic glass board	2000 x 1200	1200 x 2000	43.0
MT120240	Classic magnetic glass board	2400 x 1200	1200 x 2400	46.0
Mounting kit included Add accessories with a Basic Kit (only available for purchase with a main CHAT BOARD® product):		Total depth (glass front to wall surface): 16 mm (+/- 1 mm)		
KITBLACK	Basic kit Black	1 Black Marker Pen, 3 Chrome Magnets		
KITWHITE	Basic kit White	1 White Neon Marker Pen, 3 Chrome Magnets		

Glass

							
Grey MTG	Dove MTDO	Dark Grey MTDG ⁽¹⁾	Ink MTINK	Denim MTDE	Lavender MTL	Sky Blue MTSB	Light Blue MTLB
							
Stone MTSTO	Sand MTSA	Mocca MTM	Black MTS ⁽¹⁾	Pine MTPPI	Army Green MTAG	Khaki MTK	Lily MTLI
							
Nude MTNU	Blush MTBL	Petal MTPE	Plum MTPLU	Ruby MTRU	Red MTR	Orange MTO	Yellow MTY
							
Pure White MTPW							

⁽¹⁾We recommend the Basic Kit White

Classic

Sizes & orientation

800 mm x 500 mm / 500 mm x 800 mm

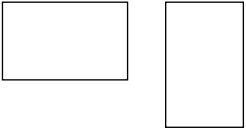

695 mm x 695 mm



900 mm x 700 mm / 700 mm x 900 mm

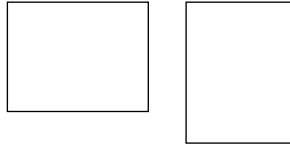

1200 mm x 585 mm / 585 mm x 1200 mm

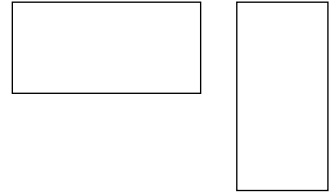

1500 mm x 600 mm / 600 mm x 1500 mm

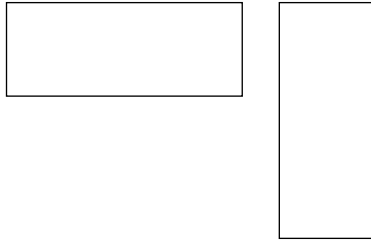

1200 mm x 900 mm / 900 mm x 1200 mm

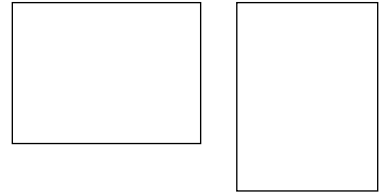

1000 mm x 1000 mm

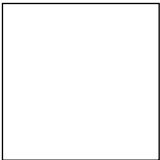

1500 mm x 1000 mm / 1000 mm x 1500 mm

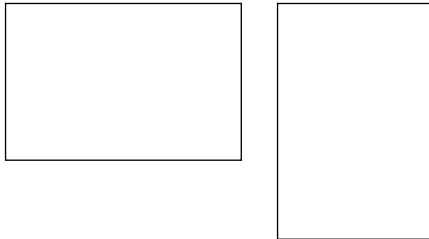

2000 mm x 1000 mm / 1000 mm x 2000 mm

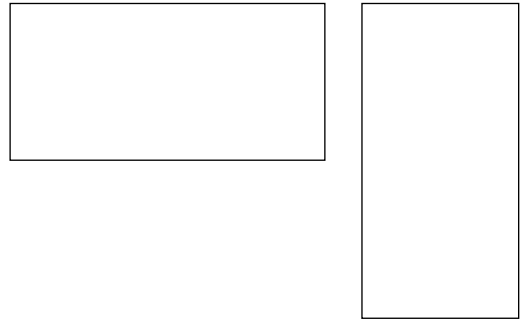

1200 mm x 1200 mm

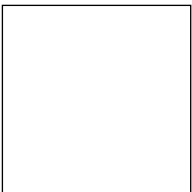

1500 mm x 1200 mm / 1200 mm x 1500 mm

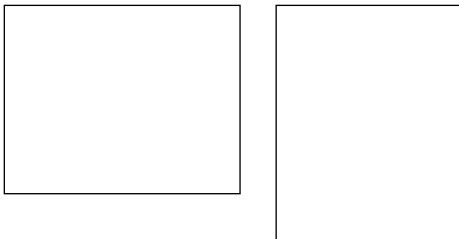

2000 mm x 1200 mm / 1200 mm x 2000 mm

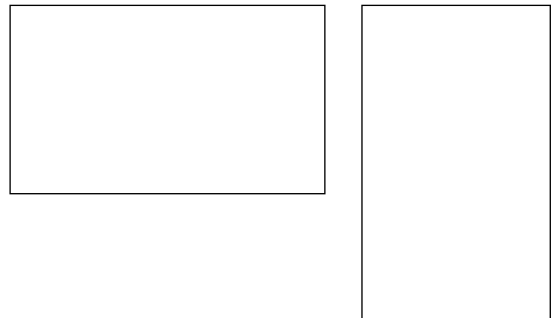

2400 mm x 1200 mm / 1200 mm x 2400 mm

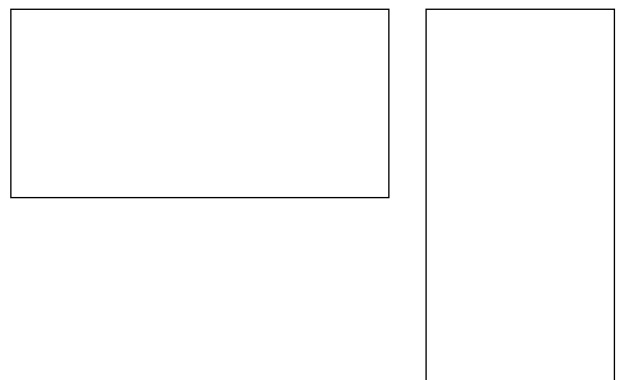

Please note

Unless otherwise clearly noted, the boards will be delivered with a hanging rail for horizontal mounting. This can be easily cut shorter for vertical mounting if needed.

[return to index](#)

Classic Surfacing^{NEW}

CHAT BOARD® Classic Surfacing provides the ideal solution for converting larger wall spaces into creative surfaces on a grand scale. Combine up to 5 pieces of the 1000 x 2000 mm Classic board in the colour(s) of your choice to create personalised wall compositions that are an exact match for your specific requirements.

CHAT BOARD® Classic Surfacing is composed of Classic boards made with 4 mm tempered safety glass, in accordance with the highest quality standards, finished with smooth C-edges and 4 mm radius corners. As a standard they are mounted vertically on the wall, but they can also be used horizontally if needed. The Classic Surfacing boards each measure 1000 x 2000 mm and they are available in 25 standard colours, which **can be combined as desired**. In addition, they can be made to order in bespoke standard RAL and NCS glass colours.

Please contact our head office with any special requests: info@chat-board.dk

Quality test

Security: EN 14434:2010



Cradle to Cradle Certified™ is a certification mark licensed by the Cradle to Cradle Products Innovation Institute



Classic Surfacing ^{NEW}

Item no.	Description	Dimensions	Weight
		(Vertically mounted)	Total
		W x H mm	kg
MTSURF2	Classic Surfacing - 2 magnetic glass boards	2000 x 2000	72.0
MTSURF3	Classic Surfacing - 3 magnetic glass boards	3000 x 2000	108.0
MTSURF4	Classic Surfacing - 4 magnetic glass board	4000 x 2000	144.0
MTSURF5	Classic Surfacing - 5 magnetic glass board	5000 x 2000	180.0
Mounting kits included Add accessories with a Basic Kit for each board (only available for purchase with a main CHAT BOARD® product):		Total depth (glass front to wall surface): 16 mm (+/- 1 mm)	
KITBLACK	Basic kit Black	1 Black Marker Pen, 3 Chrome Magnets	
KITWHITE	Basic kit White	1 White Neon Marker Pen, 3 Chrome Magnets	

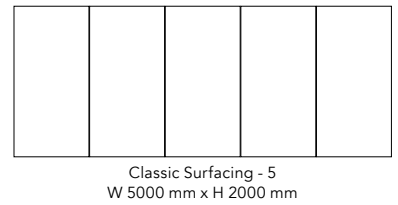
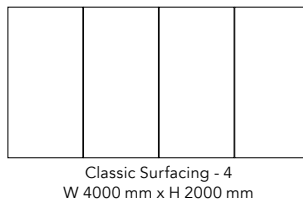
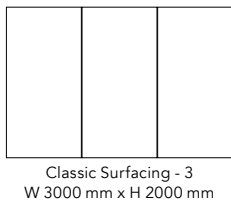
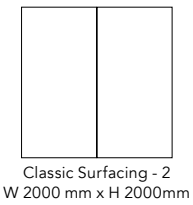

Glass



⁽¹⁾we recommend the Basic Kit White

Classic Crafted

CHAT BOARD® Classic Crafted brings a whole new perspective to its much-loved forerunner, Classic. Marrying the soft, natural warmth of oak, or the dark elegance of black lacquered ash, with our signature streamlined glass surface in one cohesive unit, Classic Crafted elegantly elevates the functional to the truly desirable. The four beautifully balanced pieces are all hand finished and tailor made to partner perfectly with other wall-mounted boards in the CHAT BOARD collection, offering endless possibilities to create carefully composed interactive wall surfaces of beauty and utility in equal amounts.

The seamless juxtaposition of contrasting, yet mutually complementing surface textures brings a fresh aesthetic dynamic and definition to the Classic board without taking away from its key function as an indispensable tool for creation and communication.

Complete your Classic Crafted composition with the Classic Crafted Keeper (see page 72), an exquisitely shaped, magnetic accessories holder, mirroring the wood veneer panels of the 'mother' board. Fully flexible and easily attached, it can be placed on both panel and glass and moved around according to mood and circumstances.

CHAT BOARD® Classic Crafted is made with 4 mm tempered safety glass, in accordance with the highest quality standards, finished with smooth C-edges and 4 mm radius corners. The wood panels and Keeper are crafted from oak or ash veneer, treated with a matt PU lacquer (clear on oak, and black on ash). All Classic Crafted boards can be mounted both horizontally and vertically (with the panel on either side, top or bottom as desired) and easily changed from one orientation to another. Classic Crafted is available in 4 standard sizes and 25 standard glass colours. In addition, they can be made to order in bespoke sizes and standard RAL and NCS glass colours.

Please contact our head office with any special requests: info@chat-board.dk

Quality test

Security: EN 14434:2010

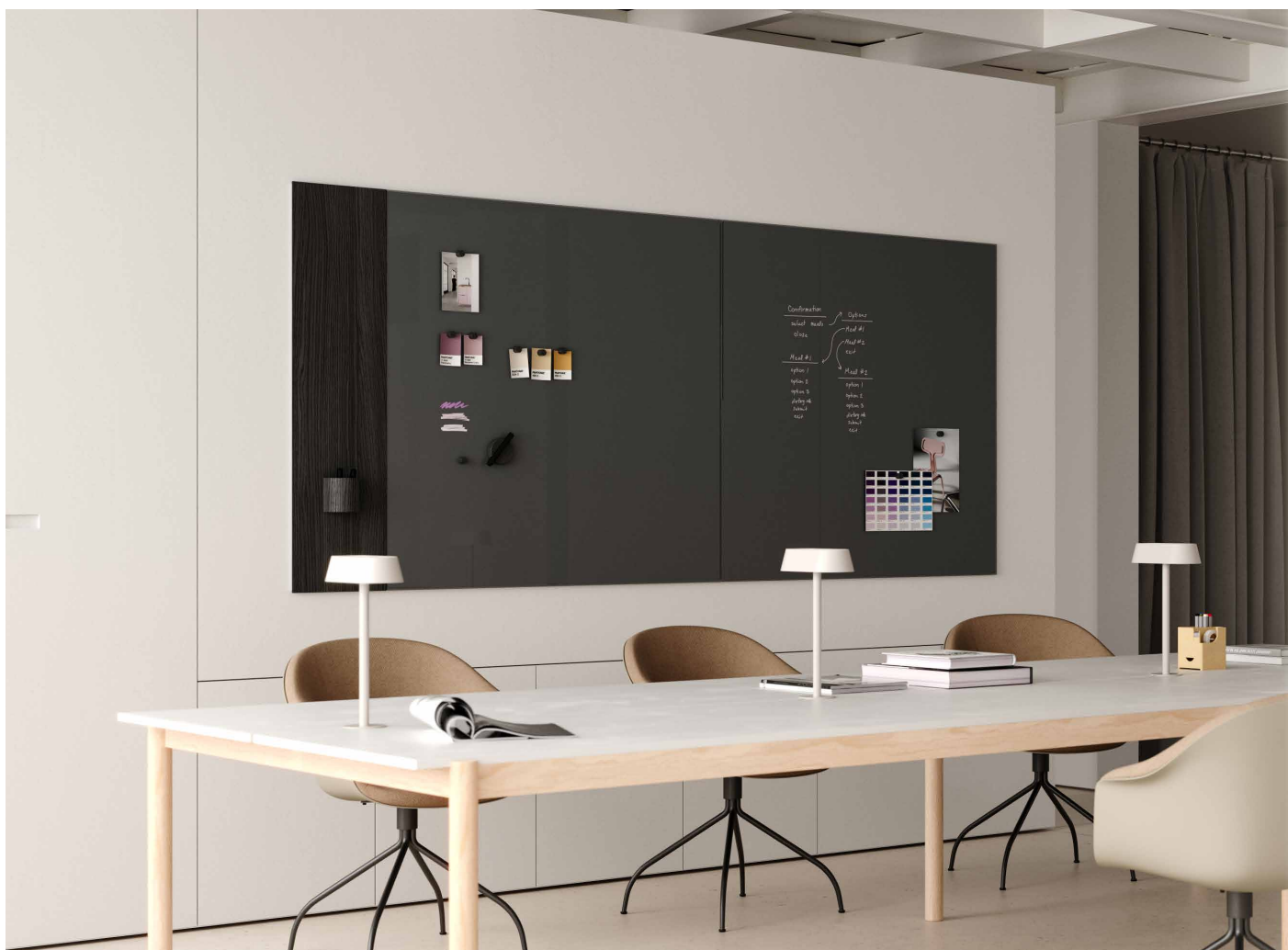

Classic Crafted

Item no.	Description	Dimensions				Weight
		Glass mm	Veneer panel mm	Horizontally mounted W x H mm	Vertically mounted W x H mm	
Oak veneer						
MTCRO7090	Classic Crafted magnetic glass board with oak veneer panel	695 x 695	200 x 695	900 x 700	700 x 900	9.2
MTCRO100120	Classic Crafted magnetic glass board with oak veneer panel	1000 x 1000	200 x 1000	1200 x 1000	1000 x 1200	16.5
MTCRO120120	Classic Crafted magnetic glass board with oak veneer panel	900 x 1200	300 x 1200	1200 x 1200	1200 x 1200	19.8
MTCRO120150	Classic Crafted magnetic glass board with oak veneer panel	1200 x 1200	300 x 1200	1500 x 1200	1200 x 1500	24.8
Black ash veneer^{NEW}						
MTCRB7090	Classic Crafted magnetic glass board with black ash veneer panel	695 x 695	200 x 695	900 x 700	700 x 900	9.2
MTCRB100120	Classic Crafted magnetic glass board with black ash veneer panel	1000 x 1000	200 x 1000	1200 x 1000	1000 x 1200	16.5
MTCRB120120	Classic Crafted magnetic glass board with black ash veneer panel	900 x 1200	300 x 1200	1200 x 1200	1200 x 1200	19.8
MTCRB120150	Classic Crafted magnetic glass board with black ash veneer panel	1200 x 1200	300 x 1200	1500 x 1200	1200 x 1500	24.8
Mounting kit included Add accessories with a Basic Kit (only available for purchase with a main CHAT BOARD® product):		Total depth (glass front to wall surface): 16 mm (+/- 1 mm)				
KITBLACK	Basic kit Black	1 Black Marker Pen, 3 Chrome Magnets				
KITWHITE	Basic kit White	1 White Neon Marker Pen, 3 Chrome Magnets				

Glass

Optional add Matt glass to Classic Crafted

Grey MTG Dove MTDO Dark Grey MTDG⁽¹⁾ Ink MTINK Denim MTDE Lavender MTL Sky Blue MTSB Light Blue MTLB

Stone MTSTO Sand MTSA Mocca MTM Black MTS⁽¹⁾ Pine MTPi Army Green MTAG Khaki MTK Lily MTLi

Nude MTNU Blush MTBL Petal MTPE Plum MTPLU Ruby MTRU Red MTR Orange MTO Yellow MTY

Pure White MTPW

⁽¹⁾We recommend the Basic Kit White

Veneer

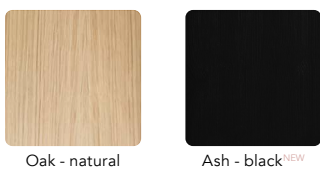

Add a Keeper



[return to index](#)

Classic Crafted

Sizes & orientation

900 mm x 700 mm / 700 mm x 900 mm

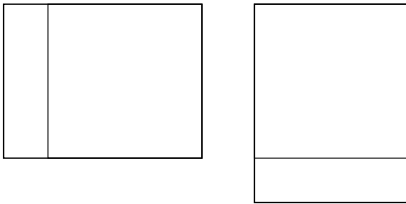

1200 mm x 1000 mm / 1000 mm x 1200 mm

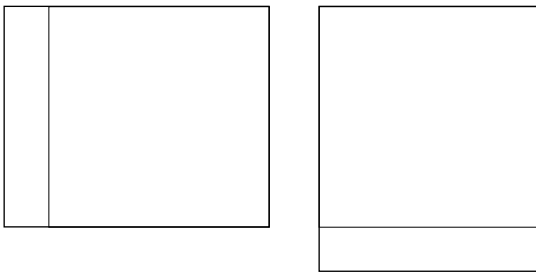

1200 mm x 1200 mm

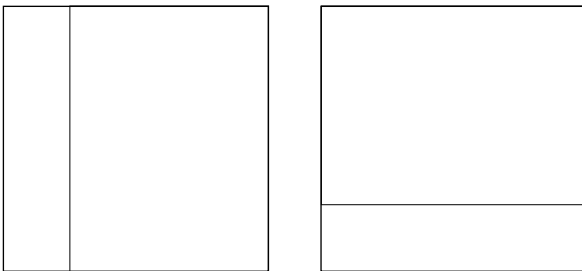

1500 mm x 1200 mm / 1200 mm x 1500 mm

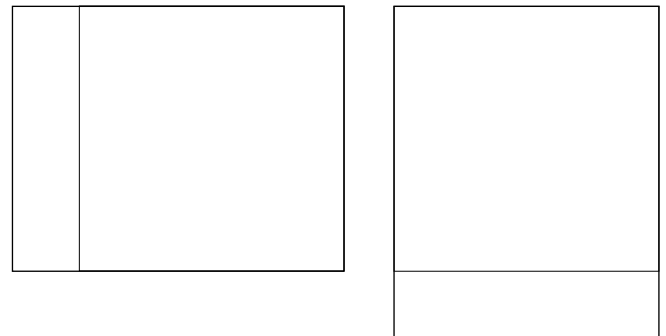

Please note

Unless otherwise clearly noted, the boards will be delivered with a hanging rail for horizontal mounting. This can be easily cut shorter for vertical mounting if needed.

Matt

CHAT BOARD® Matt, like its glossier counterpart Classic, is the ideal tool for illustrating, sharing and communicating creative ideas and thoughts, as well as providing any kind of practical information in any imaginable workspace or domestic setting. What really sets it apart, however, is the elegantly matt, yet velvety smooth, surface, which ensures minimal reflection or glare. Equally easy to clean and maintain, the CHAT BOARD® Matt will remain a pleasure to use and look at for years to come.

CHAT BOARD® Matt is made with 4 mm tempered safety glass, in accordance with the highest quality standards, finished with smooth C-edges and 4 mm radius corners. It **can be mounted both horizontally and vertically** on the wall, is easily switched from one orientation to another, and is available in 11 standard sizes and 25 standard colours. In addition, it can be made to order in bespoke sizes, shapes and standard RAL and NCS glass colours.

Please contact our head office with any special requests: info@chat-board.dk

Quality test

Security: EN 14434:2010



Matt

Item no.	Description	Dimensions		Weight kg
		Horizontally mounted	Vertically mounted	
		W x H mm	W x H mm	
MTM7090	Matt magnetic glass board	900 x 700	700 x 900	11.0
MTM58120	Matt magnetic glass board	1200 x 585	585 x 1200	12.5
MTM60150 ^{NEW}	Matt magnetic glass board	1500 x 600	600 x 1500	14.4
MTM100100	Matt magnetic glass board	1000 x 1000	1000 x 1000	16.0
MTM90120	Matt magnetic glass board	1200 x 900	900 x 1200	17.8
MTM120120	Matt magnetic glass board	1200 x 1200	1200 x 1200	25.8
MTM100150	Matt magnetic glass board	1500 x 1000	1000 x 1500	26.0
MTM120150	Matt magnetic glass board	1500 x 1200	1200 x 1500	31.0
MTM100200	Matt magnetic glass board	2000 x 1000	1000 x 2000	36.0
MTM120200	Matt magnetic glass board	2000 x 1200	1200 x 2000	43.0
MTM120240	Matt magnetic glass board	2400 x 1200	1200 x 2400	46.0
Mounting kit included Add accessories with a Basic Kit (only available for purchase with a main CHAT BOARD® product):		Total depth (glass front to wall surface): 16 mm (+/- 1 mm)		
KITBLACK	Basic kit Black	1 Black Marker Pen, 3 Chrome Magnets		
KITWHITE	Basic kit White	1 White Neon Marker Pen, 3 Chrome Magnets		

Optional choose Elements finish for Matt (with polished V edges and 90° corners)

Glass

							
Grey MTG	Dove MTDO	Dark Grey MTDG ⁽¹⁾	Ink MTINK	Denim MTDE	Lavender MTL	Sky Blue MTSB	Light Blue MTLB
							
Stone MTSTO	Sand MTSA	Mocca MTM	Black MTS ⁽¹⁾	Pine MTPi	Army Green MTAG	Khaki MTK	Lily MTli
							
Nude MTNU	Blush MTBL	Petal MTPE	Plum MTPLU	Ruby MTRU	Red MTR	Orange MTO	Yellow MTY
							
Pure White MTPW							

⁽¹⁾we recommend the Basic Kit White

Matt

Sizes & orientation

900 mm x 700 mm / 700 mm x 900 mm

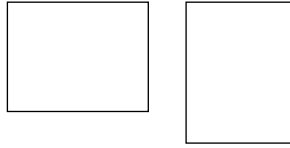

1200 mm x 585 mm / 585 mm x 1200 mm

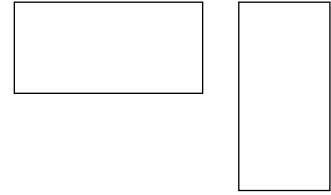

1500 mm x 600 mm / 600 mm x 1500 mm

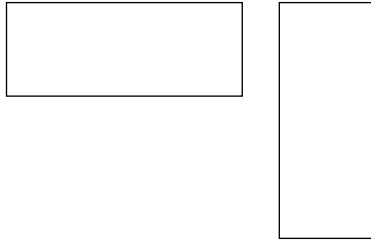

1200 mm x 900 mm / 900 mm x 1200 mm

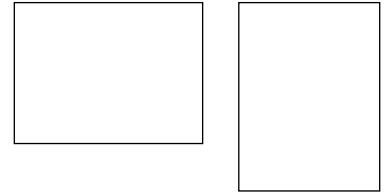

1000 mm x 1000 mm

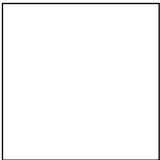

1500 mm x 1000 mm / 1000 mm x 1500 mm

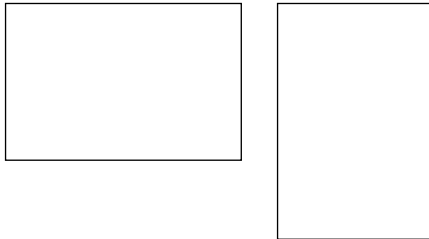

2000 mm x 1000 mm / 1000 mm x 2000 mm

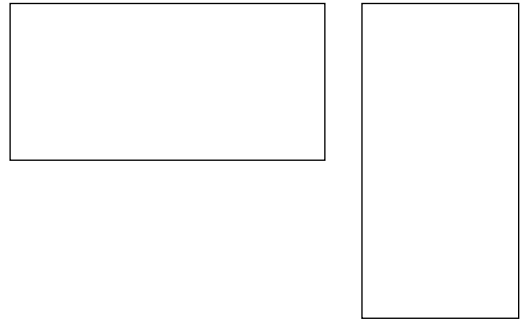

1200 mm x 1200 mm

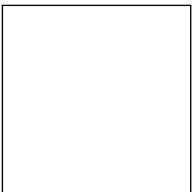

1500 mm x 1200 mm / 1200 mm x 1500 mm

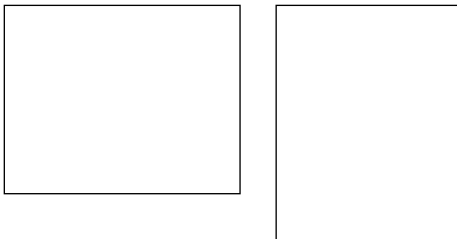

2000 mm x 1200 mm / 1200 mm x 2000 mm

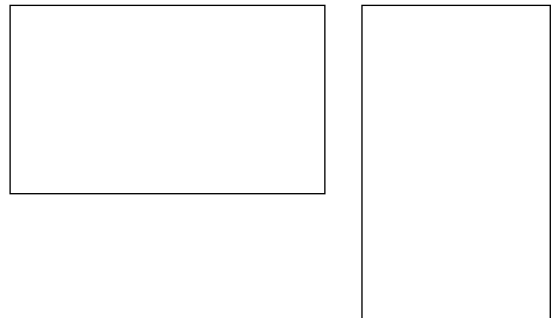

2400 mm x 1200 mm / 1200 mm x 2400 mm

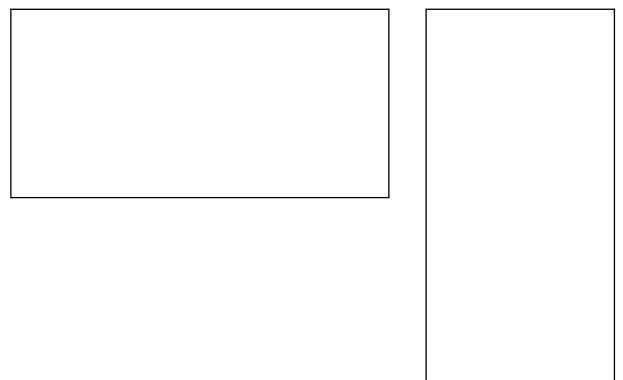

Please note

Unless otherwise clearly noted, the boards will be delivered with a hanging rail for horizontal mounting. This can be easily cut shorter for vertical mounting if needed.

[return to index](#)

Matt Surfacing^{NEW}

CHAT BOARD® Matt Surfacing provides the ideal solution for converting larger wall spaces into creative surfaces on a grand scale. Combine up to 5 pieces of the 1000 x 2000 mm Matt board in the colour(s) of your choice to create personalised wall compositions that are an exact match for your specific requirements.

CHAT BOARD® Matt Surfacing is composed of Matt boards made with 4 mm tempered safety glass, in accordance with the highest quality standards, finished with smooth C-edges and 4 mm radius corners. As a standard they are mounted vertically on the wall, but they can also be used horizontally if needed. The Matt Surfacing boards each measure 1000 x 2000 mm and they are available in 25 standard colours, which **can be combined as desired**. In addition, they can be made to order in bespoke standard RAL and NCS glass colours.

Please contact our head office with any special requests: info@chat-board.dk

Quality test

Security: EN 14434:2010



Matt Surfacing^{NEW}

Item no.	Description	Dimensions	Weight
		(Vertically mounted)	Total
		W x H mm	kg
MTMSURF2	Matt Surfacing - 2 magnetic glass boards	2000 x 2000	72.0
MTMSURF3	Matt Surfacing - 3 magnetic glass boards	3000 x 2000	108.0
MTMSURF4	Matt Surfacing - 4 magnetic glass board	4000 x 2000	144.0
MTMSURF5	Matt Surfacing - 5 magnetic glass board	5000 x 2000	180.0
Mounting kits included Add accessories with a Basic Kit for each board (only available for purchase with a main CHAT BOARD® product):		Total depth (glass front to wall surface): 16 mm (+/- 1 mm)	
KITBLACK	Basic kit Black	1 Black Marker Pen, 3 Chrome Magnets	
KITWHITE	Basic kit White	1 White Neon Marker Pen, 3 Chrome Magnets	

Optional choose Elements finish for Matt Surfacing (with polished V edges and 90° corners)

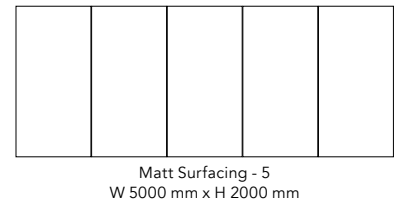
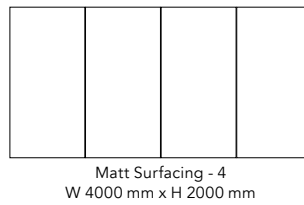
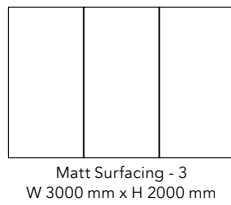
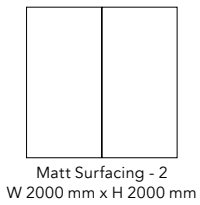

Glass



Grey MTG



Dove MTDO



Dark Grey MTDG⁽¹⁾



Ink MTINK



Denim MTDE



Lavender MTL



Sky Blue MTSB



Light Blue MTLB



Stone MTSTO



Sand MTSA



Mocca 12 MTM



Black MTS⁽¹⁾



Pine MTPi



Army Green MTAG



Khaki MTK



Lily MTLi



Nude MTNU



Blush MTBL



Petal MTPE



Plum MTPLU



Ruby MTRU



Red MTR



Orange MTO



Yellow MTY

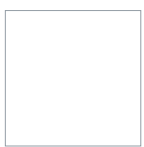

Pure White MTPW

⁽¹⁾we recommend the Basic Kit White

Elements

CHAT BOARD® Elements offers the same advantages and high quality as our Classic magnetic glass boards, in an updated design with a slightly simplified edge- and corner finish. The clean glass surface provides the perfect backdrop for visualising and communicating ideas and information in meeting-, education- or brainstorming sessions.

CHAT BOARD® Elements is made with 4 mm tempered safety glass, in accordance with the highest quality standards, finished with smooth V edges and 90° corners. It comes in a total of 5 standard colours and 6 standard sizes, which **can all be mounted both horizontally and vertically**. In addition, Elements can be made to order in bespoke sizes, shapes and standard RAL and NCS glass colours.

Please contact our head office with any special requests: info@chat-board.dk

Quality test

Security: EN 14434:2010



Cradle to Cradle Certified™ is a certification mark licensed by the Cradle to Cradle Products Innovation Institute

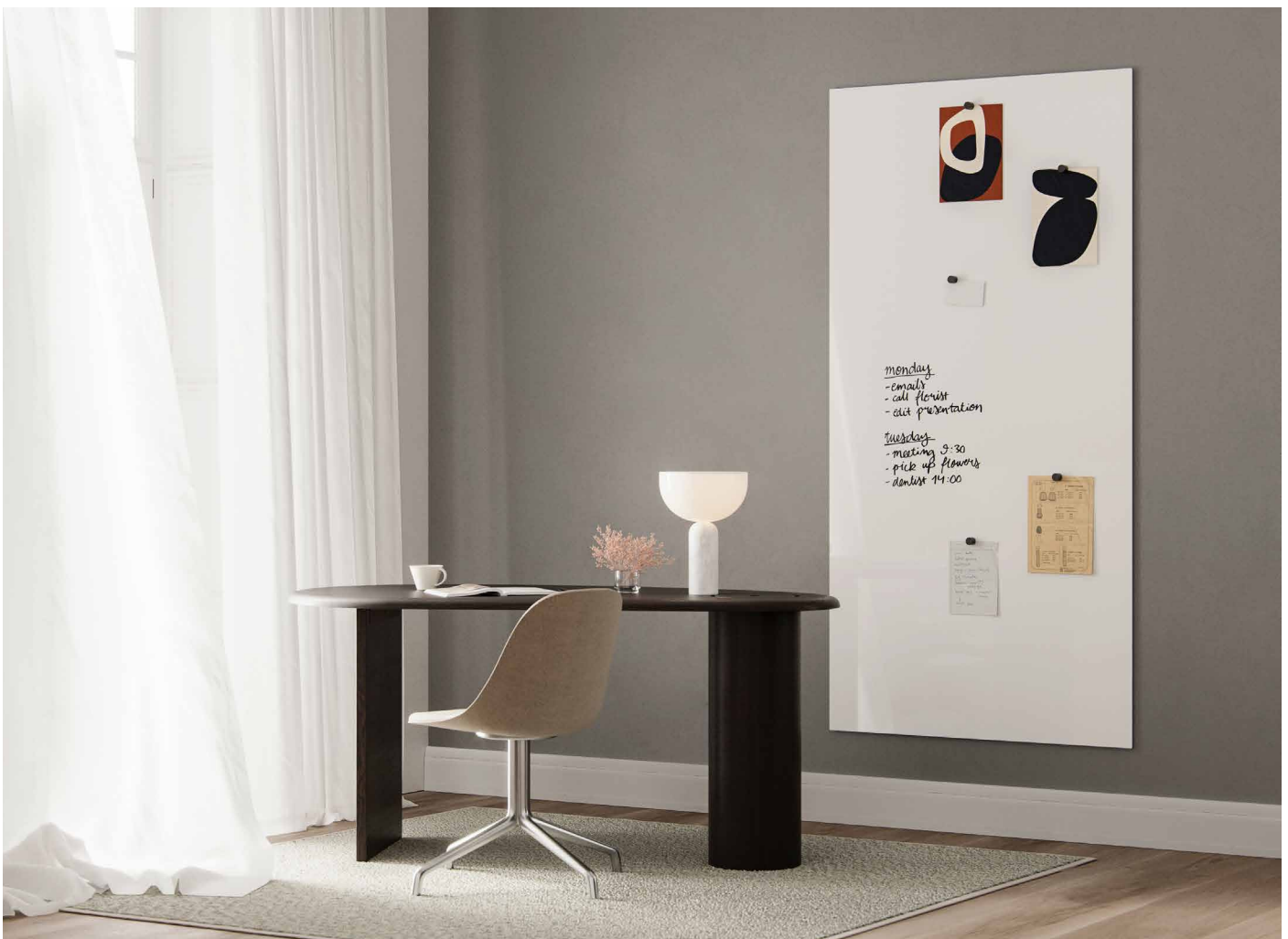

Elements

Item no.	Description	Dimensions		Weight kg
		Horizontally mounted	Vertically mounted	
		W x H mm	W x H mm	
MTEL100100	Elements magnetic glass board	1000 x 1000	1000 x 1000	16.0
MTEL90120	Elements magnetic glass board	1200 x 900	900 x 1200	17.8
MTEL100150	Elements magnetic glass board	1500 x 1000	1000 x 1500	26.0
MTEL120150	Elements magnetic glass board	1500 x 1200	1200 x 1500	31.0
MTEL100200	Elements magnetic glass board	2000 x 1000	1000 x 2000	36.0
MTEL120200	Elements magnetic glass board	2000 x 1200	1200 x 2000	43.0
Mounting kit included Add accessories with a Basic Kit (only available for purchase with a main CHAT BOARD® product):		Total depth (glass front to wall surface): 16 mm (+/- 1 mm)		
KITBLACK	Basic kit Black	1 Black Marker Pen, 3 Chrome Magnets		

Glass



Dove 35 MTDO

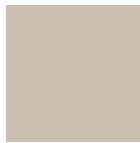

Sand 31 MTSA



Khaki 27 MTK



Sky Blue 39 MTSB



Pure White 14 MTPW

Edges - detail



Elements finish w. V edges vs. Classic (standard) finish w. C edges

Elements

Sizes & orientation

1200 mm x 900 mm / 900 mm x 1200 mm

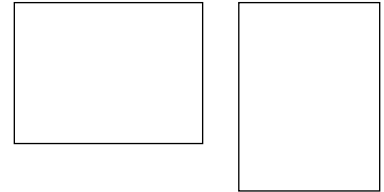

1000 mm x 1000 mm

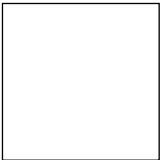

1500 mm x 1000 mm / 1000 mm x 1500 mm

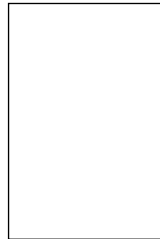
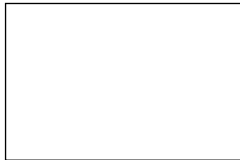

2000 mm x 1000 mm / 1000 mm x 2000 mm

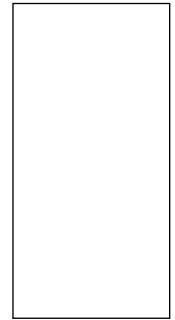
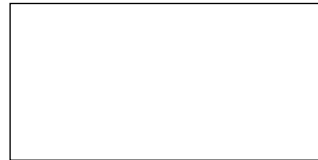

1500 mm x 1200 mm / 1200 mm x 1500 mm

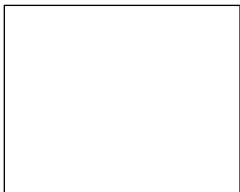

2000 mm x 1200 mm / 1200 mm x 2000 mm

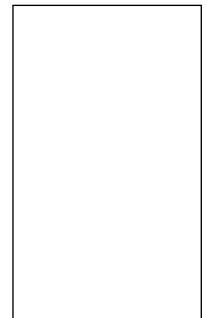
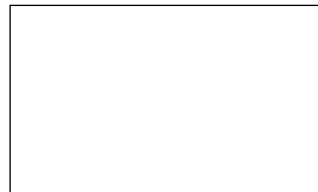

Please note

Unless otherwise clearly noted, the boards will be delivered with a hanging rail for horizontal mounting. This can be easily cut shorter for vertical mounting if needed.

Elements Surfacing^{NEW}

CHAT BOARD® Elements Surfacing provides the ideal solutions for converting larger wall spaces into creative surfaces on a grand scale. Combine up to 5 pieces of the 1000 x 2000 mm Elements board in the colour(s) of your choice to create personalised wall compositions that are an exact match for your specific requirements.

CHAT BOARD® Elements Surfacing is composed of Elements boards made with 4 mm tempered safety glass, in accordance with the highest quality standards, finished with smooth V edges and 90° corners for an extra close fit. As a standard they are mounted vertically on the wall, but they can also be used horizontally if needed. The Elements Surfacing boards each measure 1000 x 2000 mm and they are available in 5 standard colours, which **can be combined as desired**. In addition, they can be made to order in bespoke standard RAL and NCS glass colours.

Please contact our head office with any special requests: info@chat-board.dk

Quality test

Security: EN 14434:2010



Cradle to Cradle Certified™ is a certification mark licensed by the Cradle to Cradle Products Innovation Institute



Elements Surfacing^{NEW}

Item no.	Description	Dimensions	Weight
		(Vertically mounted)	Total
		W x H mm	kg
MTELSURF2	Elements Surfacing - 2 magnetic glass boards	2000 x 2000	72.0
MTELSURF3	Elements Surfacing - 3 magnetic glass boards	3000 x 2000	108.0
MTELSURF4	Elements Surfacing - 4 magnetic glass board	4000 x 2000	144.0
MTELSURF5	Elements Surfacing - 5 magnetic glass board	5000 x 2000	180.0
Mounting kits included Add accessories with a Basic Kit for each board (only available for purchase with a main CHAT BOARD® product):		Total depth (glass front to wall surface): 16 mm (+/- 1 mm)	
KITBLACK	Basic kit Black	1 Black Marker Pen, 3 Chrome Magnets	

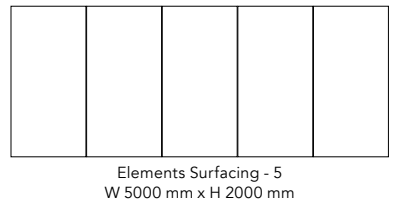
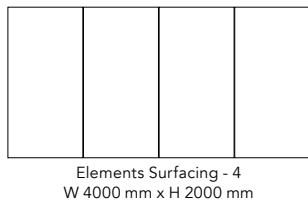
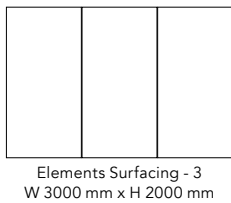
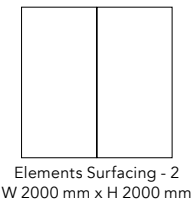

Glass

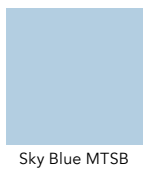
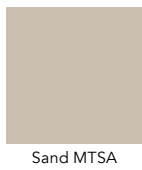

Edges - detail



Elements finish w. V edges vs. Classic (standard) finish w. C edges

Orbit^{NEW}

The new CHAT BOARD® Orbit is a playful and slightly less formal interpretation of the magnetic and writable glass board. The strong geometrical shape of the perfect circle offers the ideal starting point for getting truly creative with fun, yet functional wall compositions in professional and domestic settings.

Orbit is dressed in a choice of four fresh CHAT BOARD® colours, accompanied by a flawless white, and along with three complementary sizes the collection offers countless ways of creating combinations that add that perfectly personalised dimension to your space.

CHAT BOARD® Orbit is made with 4 mm tempered safety glass, in accordance with the highest quality standards, finished with smooth, rounded C-edges. It is available in 3 standard sizes and 5 standard colours. In addition, it can be made to order in bespoke standard RAL and NCS glass colours.

Please contact our head office with any special requests: info@chat-board.dk



Item no.	Description	Dimensions	Weight
		Ø mm	kg
ORB70	Orbit magnetic glass board	700	6.2
ORB90	Orbit magnetic glass board	900	10.2
ORB120	Orbit magnetic glass board	1200	18.1
Mounting kit included Add accessories with a Basic Kit (only available for purchase with a main CHAT BOARD® product):		Total depth (glass front to wall surface): 16 mm (+/- 1 mm)	
KITBLACK	Basic kit Black	1 Black Marker Pen, 3 Chrome Magnets	

Optional add Matt glass to Orbit

Glass



Stone MTSTO



Petal MTPE



Ink MTINK



Pine MTPI



Pure White MTPW

Sizes

Ø 700 mm

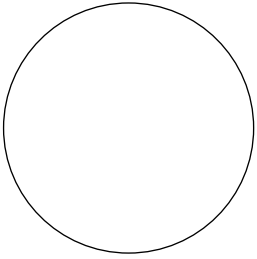

Ø 900 mm

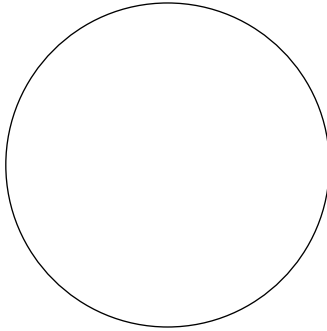

Ø 1200 mm

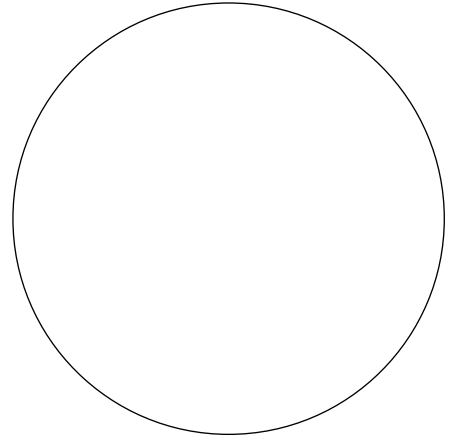

BuzziFelt

CHAT BOARD® BuzziFelt is our wall-mounted, magnetic, felt-covered pinboard. Made with 6 mm 100% recycled P.E.T. felt it is also a sound-dampening panel, making it the ideal companion for our wall-mounted glass boards. Combined with e.g. CHAT BOARD® Classic these felt-covered panels can help turn any office wall into an ultra functional, multi-textured and dynamic surface.

CHAT BOARD® BuzziFelt **can be mounted both horizontally and vertically** on the wall and is available in 7 standard sizes and 5 standard colours. In addition, it can be made to order in bespoke sizes, shapes and colours.

Please contact our head office with any special requests: info@chat-board.dk



BuzziFelt

Item no.	Description	Dimensions		Weight kg
		Horizontally mounted	Vertically mounted	
		W x H mm	W x H mm	
MTBUZZI60150 ^{NEW}	BuzziFelt magnetic, felt-covered pin board	1500 x 600	600 x 1500	5.8
MTBUZZI100100	BuzziFelt magnetic, felt-covered pin board	1000 x 1000	1000 x 1000	6.4
MTBUZZI90120	BuzziFelt magnetic, felt-covered pin board	1200 x 900	900 x 1200	6.9
MTBUZZI100150	BuzziFelt magnetic, felt-covered pin board	1500 x 1000	1000 x 1500	9.5
MTBUZZI120150	BuzziFelt magnetic, felt-covered pin board	1500 x 1200	1200 x 1500	11.4
MTBUZZI100200	BuzziFelt magnetic, felt-covered pin board	2000 x 1000	1000 x 2000	12.7
MTBUZZI120200	BuzziFelt magnetic, felt-covered pin board	2000 x 1200	1200 x 2000	15.3
Mounting kit included Add accessories with a Basic Kit (only available for purchase with a main CHAT BOARD® BuzziFelt product):		Total depth (felt front to wall surface): 18 mm (+/- 1 mm)		
KITBUZZI	Basic kit BuzziFelt	3 Chrome Magnets		

BuzziFelt



63 Off White

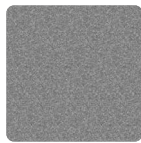

67 Stone Grey



68 Anthracite



75 Jeans

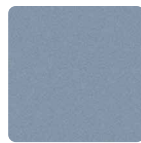

60 Light Blue

BuzziFelt

Sizes & orientation

1500 mm x 600 mm / 600 mm x 1500 mm



1200 mm x 900 mm / 900 mm x 1200 mm

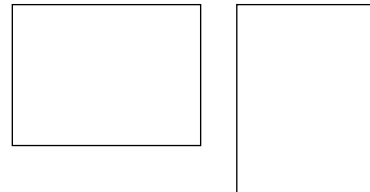

1000 mm x 1000 mm

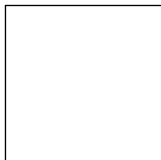

1500 mm x 1000 mm / 1000 mm x 1500 mm

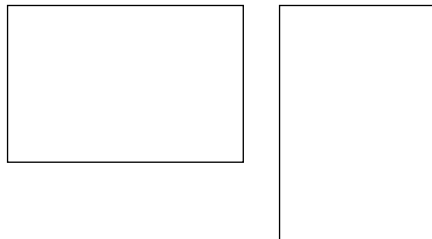

2000 mm x 1000 mm / 1000 mm x 2000 mm

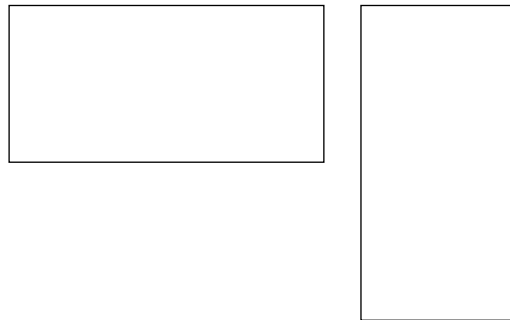

1500 mm x 1200 mm / 1200 mm x 1500 mm

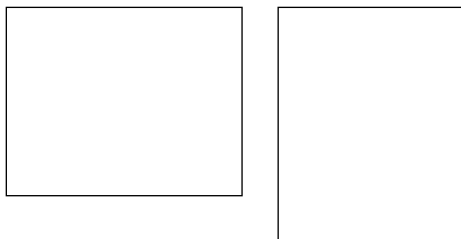

2000 mm x 1200 mm / 1200 mm x 2000 mm

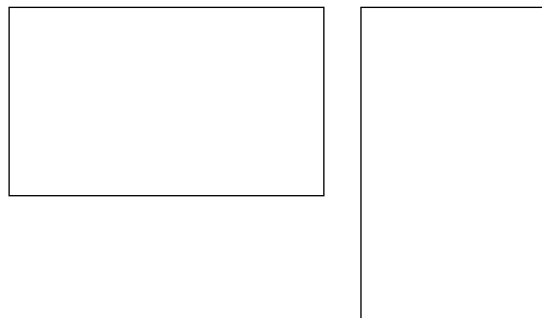

Please note

Unless otherwise clearly noted, the boards will be delivered with a hanging rail for horizontal mounting. This can be easily cut shorter for vertical mounting if needed.

Planner

CHAT BOARD® Planner is the perfect, analogue planning tool for the office or home. With a „built-in“, digitally printed weekly or yearly planner grid, according to preference, it makes it both easy and fun to share and coordinate upcoming events, make a note of dates to remember and get a common overview of current and future plans.

CHAT BOARD® Planner is made with 4 mm tempered safety glass, in accordance with the highest quality standards, finished with smooth C-edges and 4 mm radius corners. Choose from 5 different sizes (2 x Week Planner & 3 x Year Planner), 5 colours and 2 standard languages (English or Danish), all included in the standard assortment, or have it specially made to order in other bespoke sizes, languages, schedules or standard RAL or NCS glass colours.

Please contact our head office with any special requests: info@chat-board.dk



Planner

Item no.	Description	Dimensions	Weight
		(Horizontally mounted)	
		W x H mm	kg
MTPL4050	Week Planner Small magnetic glass board with weekly planner grid - choose between two layout designs (I & II)	500 x 400	3.4
MTPL5080	Week Planner Large magnetic glass board with weekly planner grid - choose between two layout designs (I & II)	800 x 500	6.8
MTPLYEAR90120	Year Planner Small magnetic glass board with yearly planner grid	1200 x 900	17.8
MTPLYEAR120150	Year Planner Medium magnetic glass board with yearly planner grid	1500 x 1200	31.0
MTPLYEAR120200	Year Planner Large magnetic glass board with yearly planner grid	2000 x 1200	43.0
Prices include mounting kit Add accessories with a Basic Kit (only available for purchase with a main CHAT BOARD® product):		Total depth (glass front to wall surface): 16 mm (+/- 1 mm)	
KITBLACK	Basic kit Black	1 Black marker pen, 3 Chrome magnets	
KIT WHITE	Basic kit White	1 White Neon Marker Pen, 3 Chrome Magnets	

Optional add Matt glass to Planner

Glass



Black MTS⁽¹⁾

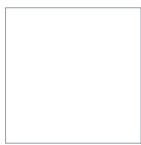

Pure White MTPW



Sand MTSA

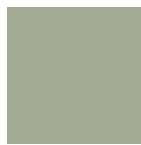

Khaki MTK



Blush MTBL

⁽¹⁾we recommend the Basic Kit White

MOBILE BOARDS & FURNISHINGS

freestanding and multifunctional solutions

SQUAD

Seamlessly shaped in the Scandinavian tradition of form meeting function in perfect unison, every member of the CHAT BOARD® SQUAD offers the ultimate in effortless functionality and uncompromising aesthetics in a coolly contemporary and streamlined design by Swedish space planners par excellence, RUMRUM. The four-piece capsule collection is made up of three freestanding units, and one self-supporting desk divider, all accompanied by their very own storage support team, the SQUAD Collectors.

The design is kept deliberately understated and minimalist. The lightweight, powder coated steel structures serve as elegantly simple, yet multifunctional frames for the writable magnetic glass surfaces of each of the SQUAD units. These are both contrasted and accentuated by perforated steel panels incorporated in the steel structure, boasting a clearly geometrical square pattern design. In SQUAD form equals function, and no feature is without purpose. The Collectors provide easily attachable, essential storage for pens and personal effects while creating an additional vertical pattern that is as individual as the user.

Designed and manufactured in Scandinavia, the SQUAD units are delivered flat packed and easily assembled on site, thus reducing both shipping costs and environmental impact.

The CHAT BOARD® SQUAD steel frames are powder coated in Signal White (RAL 9003) or Jet Black (RAL 9005) and are mounted with 4 mm tempered safety glass, in accordance with the highest quality standards, finished with smooth C-edges and 4 mm radius corners. They are available in 25 standard glass colours as well as 5 different BuzziFelt shades (to order on SQUAD Teacher and Professor). Bespoke glass colours (standard RAL or NCS) can be made to order upon request.

Please contact our head office with any special requests: info@chat-board.dk



Cradle to Cradle Certified™ is a certification mark licensed by the Cradle to Cradle Products Innovation Institute



SQUAD

Item no.	Description	Dimensions		Weight kg
		Glass W x H mm	Total size (incl. caster wheels) W x H x D mm	
SQRU	The SQUAD Runner magnetic glass board on a perforated steel base	585 x 1200	620 x 1892 x 513	24.0
SQTE	The SQUAD Teacher magnetic glass board on a perforated steel base	900 x 1200	1215 x 1830 x 476	39.5
SQPR	The SQUAD Professor magnetic glass board on a perforated steel base	1200 x 1200	1515 x 1830 x 476	49.0
Optional add-on: extra glass (mounted on the back)		Glass (back) W x H mm		kg
SQTEGLASS	extra magnetic glass for the SQUAD Teacher (back)	900 x 1200		11.9
SQPRGLASS	extra magnetic glass for the SQUAD Professor (back)	1200 x 1200		15.9
Optional add-on: BuzziFelt (mounted on the back)		BuzziFelt (back) W x H mm		kg
SQTEBUZZI	sound dampening BuzziFelt pin board for the SQUAD Teacher (back)	900 x 1200		1.5
SQPRBUZZI	sound dampening BuzziFelt pin board for the SQUAD Professor (back)	1200 x 1200		2.0
Optional add-on: caster wheels			Ø mm	
SQSET3	set of 3 brake caster wheels for the SQUAD Runner (in black or white)		65	
SQSET4	set of 4 brake caster wheels for the SQUAD Teacher & Professor (in black or white)		65	
Desk screen		Glass & BuzziFelt W x H mm	Total size W x H x D mm	kg
SQPO	The SQUAD Poet movable desk divider with magnetic glass board and BuzziFelt pin board	663 x 363	900 x 411 x 142	8.5
Storage			W x H x D mm	kg
SQCOLOW	The SQUAD Collector Low attachable storage unit		166 x 36 x 66	0.3
SQCOHIGH	The SQUAD Collector High attachable storage unit		66 x 106 x 66	0.4
SQCOLONG	The SQUAD Collector Long attachable storage unit		166 x 106 x 66	0.5
Add accessories with a Basic Kit (only available for purchase with a main CHAT BOARD® product):				
KITBLACK	Basic kit Black	1 Black Marker Pen, 3 Chrome Magnets		
KITWHITE	Basic kit White	1 White Neon Marker Pen, 3 Chrome Magnets		

Optional add Matt glass to SQUAD

Go to the next page for SQUAD colour options

[return to index](#)

SQUAD

Variants, dimensions & colours

SQUAD Runner

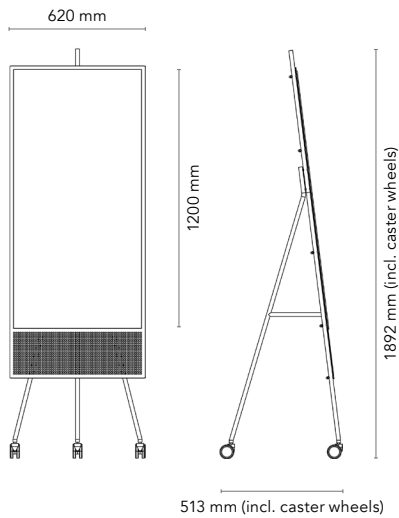

SQUAD Teacher

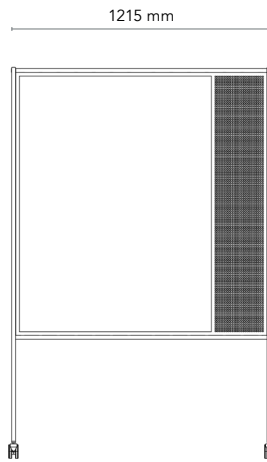

SQUAD Professor

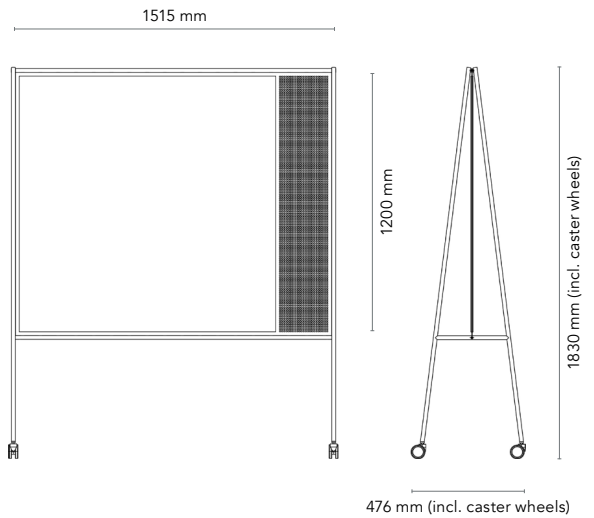

SQUAD Poet

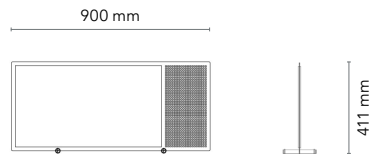

Please note

Unless otherwise clearly noted, the perforated steel panel will always be on the right-hand side of the glass (front).

Glass

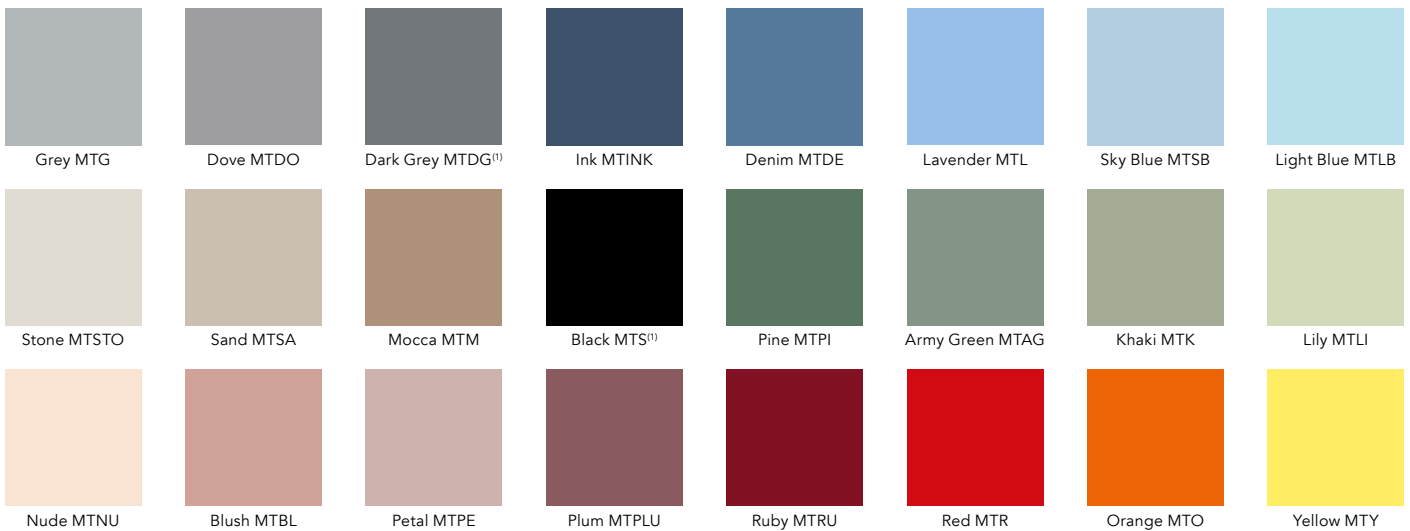

⁽¹⁾we recommend the Basic Kit White

BuzziFelt (optional)



Steel

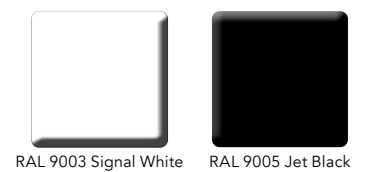

[return to index](#)

SQUAD Solid

With CHAT BOARD® SQUAD Solid we have taken the SQUAD collection to the next level of accessibility and effortlessness. Peeling away any hint of excess, the design has been brought back to its essence, only to resurface in a core collection of pared-back pieces with full focus on their key function: providing the ideal starting point for creative expression and interaction.

SQUAD Solid is based 1:1 on the original designs, only reincarnated in clean-cut silhouettes with a strong, minimalist aesthetic approach. Boasting the same qualities and advantages as their counterparts, the three mutually complementing pieces join forces in this collection of flexible, freestanding units, all created to connect and separate as desired.

All SQUAD Solid units are delivered flat packed and easily assembled on site, reducing both shipping costs and environmental impact.

The CHAT BOARD® SQUAD Solid steel frames are powder coated in Signal White (RAL 9003) or Jet Black (RAL 9005) and are mounted with 4 mm tempered safety glass, in accordance with the highest quality standards, finished with smooth C-edges and 4 mm radius corners. They are available in 25 standard glass colours as well as 5 different BuzziFelt shades (to order on SQUAD Solid Teacher and SQUAD Solid Professor). Bespoke glass colours (standard RAL or NCS) can be made to order upon request.

Please contact our head office with any special requests: info@chat-board.dk



Cradle to Cradle Certified™ is a certification mark licensed by the Cradle to Cradle Products Innovation Institute



SQUAD Solid

Item no.	Description	Dimensions		Weight kg
		Glass W x H mm	Total size (incl. caster wheels) W x H x D mm	
SQSORU	The SQUAD Solid Runner magnetic glass board on a smooth steel base	585 x 1200	620 x 1892 x 513	24.0
SQSOTE	The SQUAD Solid Teacher magnetic glass board on a smooth steel base	900 x 1200	1215 x 1830 x 476	39.5
SQSOPR	The SQUAD Solid Professor magnetic glass board on a smooth steel base	1200 x 1200	1515 x 1830 x 476	49.0
Optional add-on: extra glass (mounted on the back)		Glass (back)		
		W x H mm		kg
SQTEGLASS	extra magnetic glass for the SQUAD Solid Teacher (back)	900 x 1200		11.9
SQPRGLASS	extra magnetic glass for the SQUAD Solid Professor (back)	1200 x 1200		15.9
Optional add-on: BuzziFelt (mounted on the back)		BuzziFelt (back)		
		W x H mm		kg
SQTEBUZZI	sound dampening BuzziFelt pin board for the SQUAD Solid Teacher (back)	900 x 1200		1.5
SQPRBUZZI	sound dampening BuzziFelt pin board for the SQUAD Solid Professor (back)	1200 x 1200		2.0
Optional add-on: caster wheels			Ø mm	
SQSET3	set of 3 brake caster wheels for the SQUAD Solid Runner (in black or white)		65	
SQSET4	set of 4 brake caster wheels for the SQUAD Solid Teacher & Professor (in black or white)		65	
Add accessories with a Basic Kit (only available for purchase with a main CHAT BOARD® product):				
KITBLACK	Basic kit Black	1 Black Marker Pen, 3 Chrome Magnets		
KITWHITE	Basic kit White	1 White Neon Marker Pen, 3 Chrome Magnets		

Optional add Matt glass to SQUAD Solid

Go to the next page for SQUAD Solid colour options

[return to index](#)

SQUAD Solid

Variants, dimensions & colours

SQUAD Solid Runner

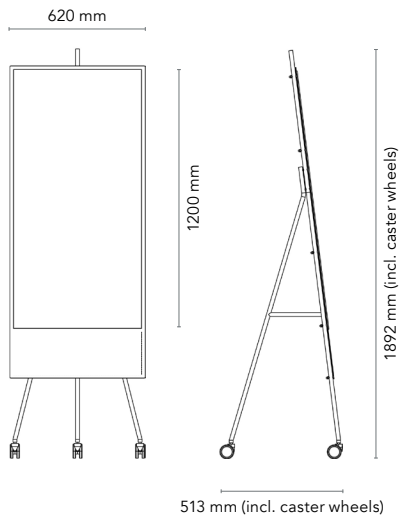

SQUAD Solid Teacher

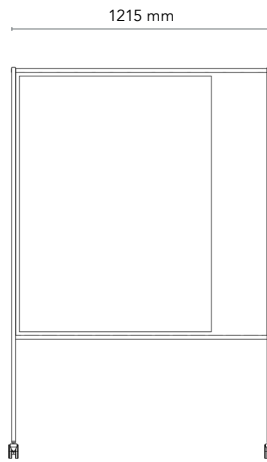

SQUAD Solid Professor

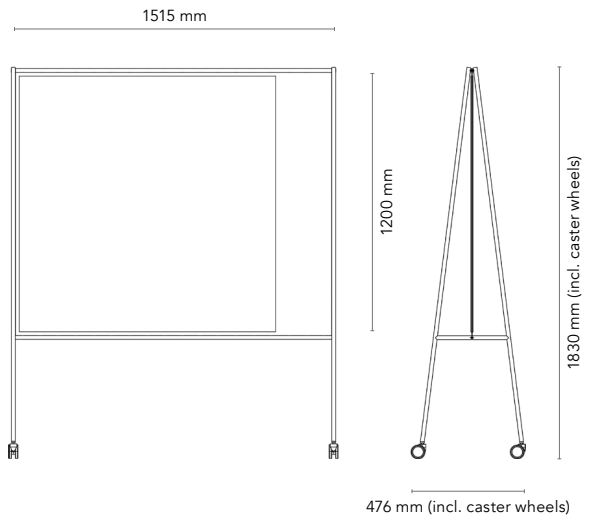

Please note

Unless otherwise clearly noted, the bare steel panel will always be on the right-hand side of the glass (front).

Glass



(1)we recommend the Basic Kit White

BuzziFelt (optional)



Steel



[return to index](#)

Mobile

CHAT BOARD® Mobile provides the ultimate, multi-purpose solution for the dynamic workplace. With its ingenious design, sturdy construction and ultra-stable, yet easily movable, steel base it is virtually impossible to overturn, meaning there is plenty of room to get carried away in the creative process. Besides boasting one of our signature writable, magnetic glass boards on the front, the Mobile can also be fitted with a sound-dampening BuzziFelt pin board, or an additional magnetic glass panel, on the back.

CHAT BOARD® Mobile is made with 4 mm tempered safety glass, in accordance with the highest quality standards, finished with smooth C-edges and 4 mm radius corners. It is available in 2 standard sizes and 25 standard glass colours. In addition, it can be made to order in bespoke standard RAL or NCS glass colours, as well as in alternative RAL base colours, besides the standard Signal White (RAL 9003) and Jet Black (RAL 9005).

Add a digital dimension to Mobile by including a TV bracket (see page 81), preinstalled from the factory and ready for the LCD screen of your choice.

Please contact our head office with any special requests: info@chat-board.dk





















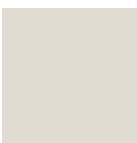





Cradle to Cradle Certified™ is a certification mark licensed by the Cradle to Cradle Products Innovation Institute

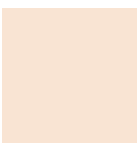

Mobile

Item no.	Description	Dimensions		Weight kg
		Glass W x H mm	Total size W x H x D mm	
White steel				
MCBW60	Mobile Executive magnetic glass board on a movable, white steel base	585 x 1200	600 x 1795 x 480	48.0
MCBW120	Mobile Conference magnetic glass board on a movable, white steel base	1200 x 1200	1200 x 1795 x 480	85.0
Black steel				
MCBB60	Mobile Executive magnetic glass board on a movable, black steel base	585 x 1200	600 x 1795 x 480	48.0
MCBB120	Mobile Conference magnetic glass board on a movable, black steel base	1200 x 1200	1200 x 1795 x 480	85.0
Optional add-on: extra glass (mounted on the back)				
		Glass (back) W x H mm		kg
BSG60	extra magnetic glass for Mobile Executive (back)	585 x 1200		7.7
BSG120	extra magnetic glass for Mobile Conference (back)	1200 x 1200		15.9
Optional add-on: BuzziFelt (mounted on the back)				
		BuzziFelt (back) W x H mm		kg
BUZZI60	sound dampening BuzziFelt pin board for Mobile Executive (back)	585 x 1200		1.0
BUZZI120	sound dampening BuzziFelt pin board for Mobile Conference (back)	1200 x 1200		2.0
Add accessories with a Basic Kit (only available for purchase with a main CHAT BOARD® product):				
KITBLACK	Basic kit Black	1 Black Marker Pen, 3 Chrome Magnets		
KITWHITE	Basic kit White	1 White Neon Marker Pen, 3 Chrome Magnets		

Glass Optional add Matt glass to Mobile

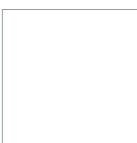
 Grey MTG	 Dove MTDO	 Dark Grey MTDG ⁽¹⁾	 Ink MTINK	 Denim MTDE	 Lavender MTL	 Sky Blue MTSB	 Light Blue MTLB
 Stone MTSTO	 Sand MTSA	 Mocca MTM	 Black MTS ⁽¹⁾	 Pine MTPi	 Army Green MTAG	 Khaki MTK	 Lily MTLi
 Nude MTNU	 Blush MTBL	 Petal MTPE	 Plum MTPLU	 Ruby MTRU	 Red MTR	 Orange MTO	 Yellow MTY
 Pure White MTPW							

⁽¹⁾we recommend the Basic Kit White

BuzziFelt (optional)

 63 Off White	 67 Stone Grey	 68 Anthracite	 75 Jeans	 60 Light Blue
--	--	--	---	--

Steel

 RAL 9003 Signal White	 RAL 9005 Jet Black
--	---

[return to index](#)

Mobile

Variants & dimensions

Mobile Executive

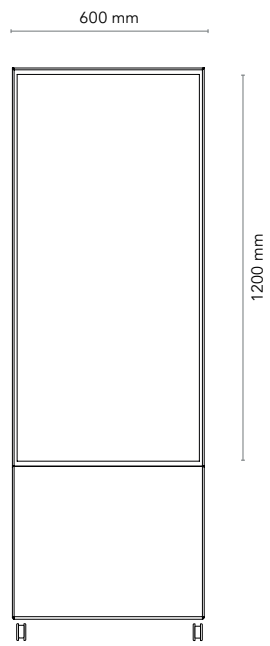

Mobile Conference

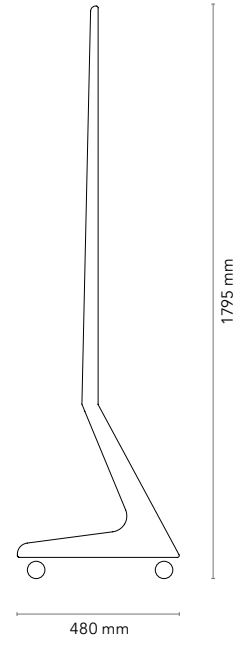
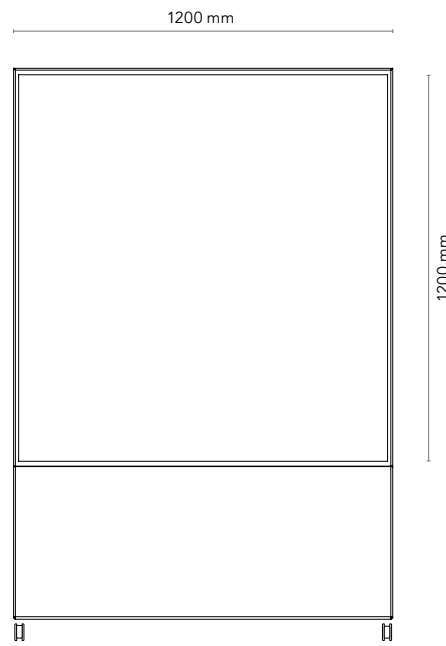

Move Acoustic

CHAT BOARD® Move Acoustic seamlessly combines the signature magnetic and writable glass board with a class A acoustic panel in two perfectly proportioned movable room dividers, created to shape multi-functional and creative spaces within spaces. Perfectly finished in Remix Screen (90% new wool, worsted, 10% nylon) or Relate Screen (100% Trevira CS) fabric by Kvadrat and featuring an ingenious, “stackable” cross-base, which allows you to store several units in even the smallest space, Move Acoustic offers style as well as substance without compromising on either.

The writable glass surface is the ideal facilitator of free-flowing brainstorming sessions and provides the obvious focal point of shared ideas and information in the corporate conference room, open office space and classroom alike, while its high-performing acoustic panel ensures the balance in visual and auditory exchange.

Ensuring cost-effective and safe transportation, the wide version is delivered in two pieces and easily assembled on site.

The movable aluminium base is powder coated in Jet Black (RAL 9005) and fitted with brake casters for added stability. The glass is 4 mm tempered safety glass, in accordance with the highest quality standards, finished with smooth C-edges and 4 mm radius corners. The wide Move Acoustic comes prepared to be mounted with the TV bracket* of your choice (not included), and both sizes are available in 25 standard glass colours and can also be made to order in bespoke standard RAL or NCS glass colours. The standard assortment includes 6 Remix Screen and 6 Relate Screen fabric colours by Kvadrat, but requests for alternative colours and varieties can be accommodated on demand.

*NB TV screen should not exceed dim. 50"/ W 1110 x H 600 mm

Please contact our head office with any special requests: info@chat-board.dk



Move Acoustic

Item no.	Description	Dimensions		Weight
		Glass & panel	Total size	
		W x H mm	W x H x D mm	kg
CBMOVES	Move Acoustic Slim movable room divider with magnetic glass board and acoustic panel	600 x 1500	600 x 1900 x 480	34.0
CBMOVEA	Move Acoustic movable room divider with magnetic glass board and acoustic panel	1200 x 1500	1200 x 1900 x 480	65.0

Add accessories with a Basic Kit
(only available for purchase with a main CHAT BOARD® product):

KITBLACK	Basic kit Black	1 Black Marker Pen, 3 Chrome Magnets
KITWHITE	Basic kit White	1 White Neon Marker Pen, 3 Chrome Magnets

Optional add Matt glass to Move Acoustic

Glass



⁽¹⁾we recommend the Basic Kit White

Fabric by Kvadrat



Aluminium



[return to index](#)

Move Acoustic

Variants & dimensions

Move Acoustic Slim

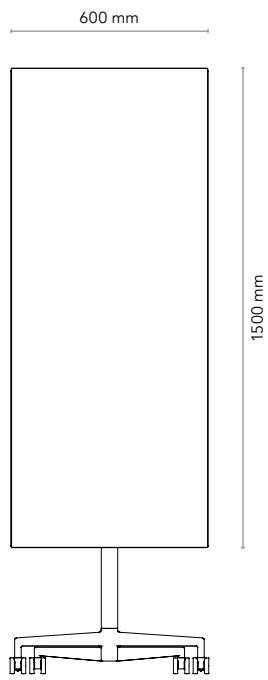

Move Acoustic

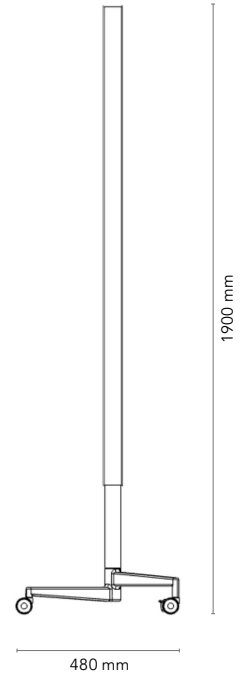
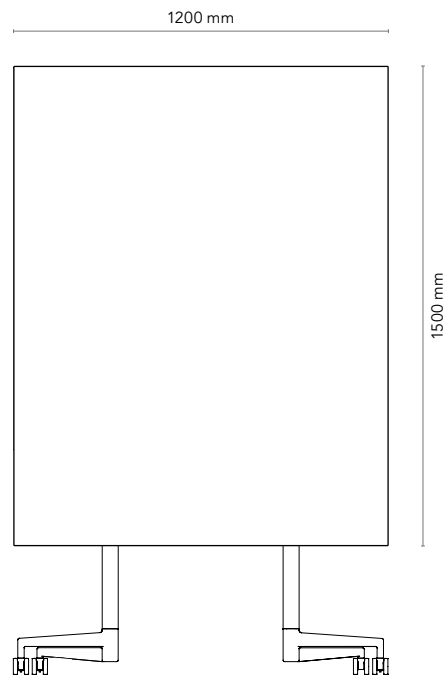



Dynamic

Created by Claus Jakobsen, CHAT BOARD® Dynamic bridges the gap between essential workspace fittings and full-fledged furniture in an ingenious framework design, developed to provide flexible, free-flowing, and multifunctional dimensions to professional, educational, and creative spaces.

Timeless and adaptable by nature, Dynamic was built to accommodate a working world of a digital age, but it was shaped by a profound appreciation of the fundamentally human need to express itself through analogue means.

The Dynamic collection carefully translates two key themes and two base varieties into 4 different self-contained units, each offering a series of features, functions and add-ons that allow it to stand proudly and purposefully on its own, or to partner up with one or more companions to sculpt and define changeable spaces within spaces.

Inviting architects and space planners to create individual and bespoke solutions, Dynamic offers a wide range of combinations, spanning across a variety of materials, finish textures and colour options.

Sustainability is at the heart of the CHAT BOARD design philosophy, and each component and raw material of the Dynamic product offering has been carefully sourced to reduce the carbon footprint across each stage of the manufacturing process.

Dynamic units are delivered pre-assembled according to order specifications, ready for the final fitting of caster wheels and glass board(s) on site.

Dynamic Wood Acoustic

CHAT BOARD® Dynamic Wood Acoustic combines the noble elegance of carefully composed, solid wood slat surfaces with the soft efficiency of acoustic felt, exquisitely contrasting the smoothness of the glass board.

Dynamic Wood Acoustic comes in two variants, Full Coverage and Shelf, each offering a broad selection of combinations across materials, colours, and optional add-ons. The Full Coverage variant delivers full-scale, mobile room dividing performance with a built-in writable glass board on one side, and your choice of functional surface on the other, including an LCD flat screen ready solution. The Shelf variant ingeniously combines the agile flexibility of a movable partition wall with a useful shelving system to provide equal parts storage and writing surface in a design where one side mirrors the other for double-sided benefit. As a new addition to the collection, the Shelf frame can be fitted with three plant boxes; the perfect way to bring a touch of nature into the workspace.

The Dynamic Wood Acoustic frames and slats are all manufactured from solid wood (spruce or oak), finished with a matt PU lacquer.

The acoustic AQsorb felt used between the wooden slats and for the optional LCD panel solution is a made from 100% recyclable PET, incl. 90% recycled PET from marine debris (plastic bottles), and has a thickness of 9 mm.

Aluminium parts (feet, shelves, shelf supports and bookends) are powder coated in Signal White (RAL 9003) or Jet Black (RAL 9005).

The Dynamic Wood Acoustic units are made easily mobile by the Ø75 mm soft brake casters, matched to your choice of wood/felt combination: white/grey with white spruce, and black/black with natural oak and black oak.

The integrated glass boards are made with 4 mm tempered safety glass, in accordance with the highest quality standards, finished with smooth C-edges and 4 mm radius corners. Choose between a glossy Classic and a velvety Matt finish as well as a palette of 25 standard glass colours. In addition, the glass can also be made to order in bespoke standard RAL or NCS colours, available for glass.

Please contact our head office with any special requests: info@chat-board.dk



Dynamic Wood Acoustic Full Coverage

Item no.	Description	Colour	Dimensions	
1				
FRAME		Wood	W x H x D mm	
DYNFCFR-WS	Dynamic Full Coverage wood frame in white pigmented spruce	white spruce ^A	1290 x 1890 x 120	
DYNFCFR-OAK	Dynamic Full Coverage wood frame in clear matt lacquered oak	natural oak ^B	1290 x 1890 x 120	
DYNFCFR-BO ^{NEW}	Dynamic Full Coverage wood frame in black matt lacquered oak	black oak ^C	1290 x 1890 x 120	
2				
SLATS & ACOUSTIC AQSORB PET FELT (FRONT AND BACK)		Wood / AQsorb felt	Front panel W x H mm	Back panel W x H mm
DYNFCAQ-WS	Dynamic wood slats in white pigmented spruce with AQsorb PET felt in soft white	white spruce /soft white ^A	1225 x 176	1225 x 1738
DYNFCAQ-OAK	Dynamic wood slats in clear matt lacquered oak with AQsorb PET felt in black	natural oak /black ^B	1225 x 176	1225 x 1738
DYNFCAQ-BO ^{NEW}	Dynamic wood slats in black matt lacquered oak with AQsorb PET felt in black	black oak /black ^C	1225 x 176	1225 x 1738
or:				
2-LCD				
SLATS & ACOUSTIC AQSORB PET FELT - LCD READY^{NEW} (FRONT AND BACK)		Wood / AQsorb felt	Front panel W x H mm	Back panel W x H mm
DYNFCAQ-WS-LCD	Dynamic wood slats in white pigmented spruce with AQsorb PET felt in soft white + back panel for flat screen installation in AQsorb PET felt in soft white	white spruce /soft white ^A + soft white ^A	1225 x 176	1225 x 176 1200 x 1500 (felt screen panel)
DYNFCAQ-OAK-LCD	Dynamic wood slats in clear matt lacquered oak with AQsorb PET felt in black + back panel for flat screen installation in AQsorb PET felt in black	natural oak /black ^B + black ^{B/C}	1225 x 176	1225 x 176 1200 x 1500 (felt screen panel)
DYNFCAQ-BO-LCD	Dynamic wood slats in black matt lacquered oak with AQsorb PET felt in black + back panel for flat screen installation in AQsorb PET felt in black	black oak /black ^C + black ^{B/C}	1225 x 176	1225 x 176 1200 x 1500 (felt screen panel)
NB When choosing the Dynamic Wood Acoustic LCD solution, the frame will be fitted with a circular cable entry + cover* on both sides of the frame				
3				
FEET			W x H x D mm	
DYNFE-W	Dynamic set of 2 aluminium feet for casters	white ^A	38 x 40 x 420	
DYNFE-B	Dynamic set of 2 aluminium feet for casters	black ^{B/C}	38 x 40 x 420	
4				
CASTERS			Ø mm	
DYNCA-W	Dynamic set of 4 soft brake casters	white/grey ^A	75	
DYNCA-B	Dynamic set of 4 soft brake casters	black/black ^{B/C}	75	
5				
GLASS BOARD			W x H mm	kg
MT120150	Classic magnetic glass board	Pure White	1200 x 1500	31.0
MT120150	Classic magnetic glass board	other colours	1200 x 1500	31.0
MTM120150	Matt magnetic glass board	Pure White	1200 x 1500	31.0
MTM120150	Matt magnetic glass board	other colours	1200 x 1500	31.0
Add accessories with a Basic Kit (only available for purchase with a main CHAT BOARD® product):				
KITBLACK	Basic kit Black	1 Black Marker Pen, 3 Chrome Magnets		
KITWHITE	Basic kit White	1 White Neon Marker Pen, 3 Chrome Magnets		

NB Predefined colour & material combinations:

Go to page 64 for colours & materials

^AWhite spruce + soft white AQsorb felt + white feet + white/grey casters (+*cable entry cover in white)

^{B/C}Natural/black oak + black AQsorb felt + black feet + black casters (+*cable entry cover in black)

Other combinations are available upon request, for 25+ units

[return to index](#)

Dynamic Wood Acoustic Full Coverage

Variants & dimensions

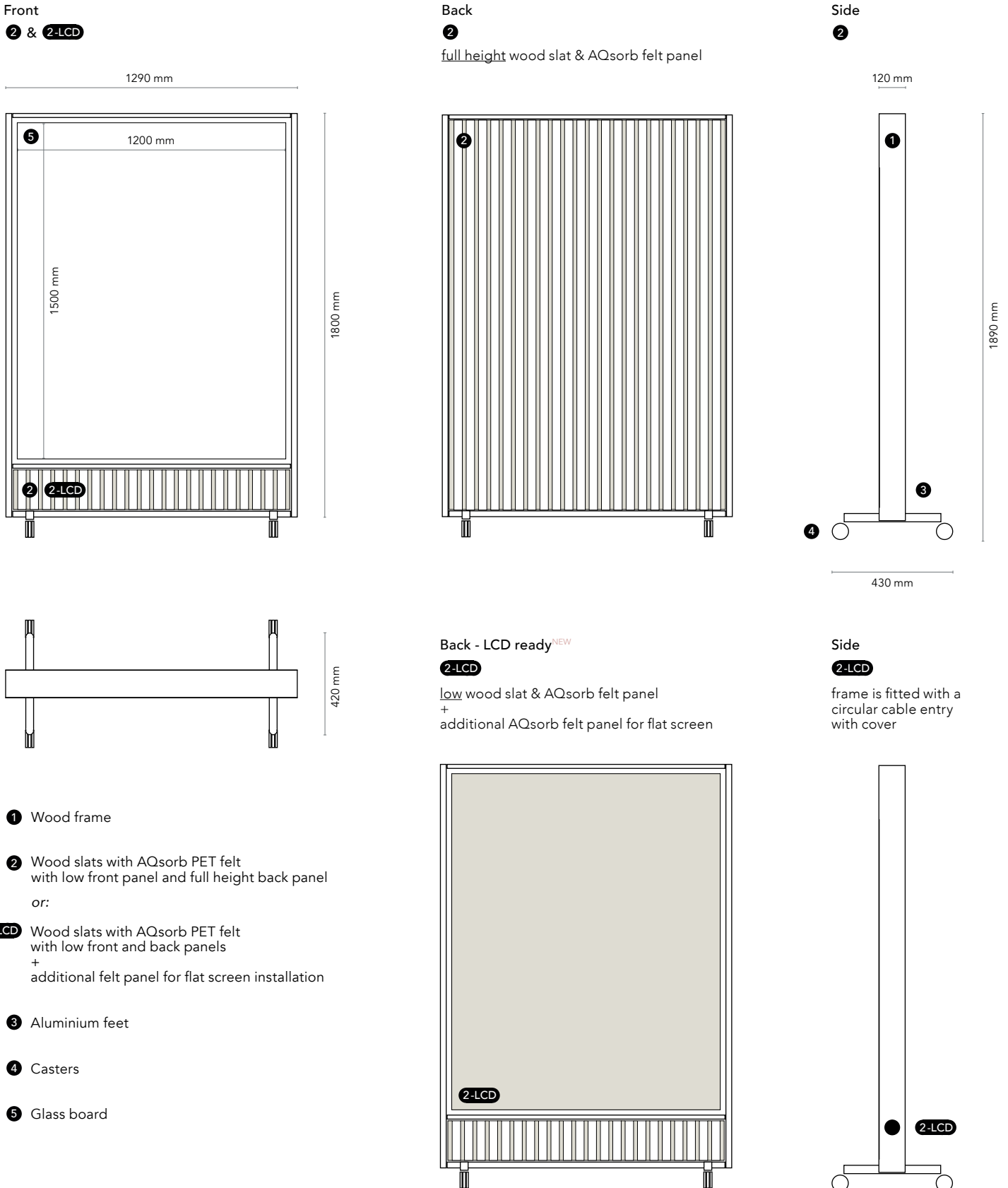

[return to index](#)

Dynamic Wood Acoustic Full Coverage

Suggested combinations

Front



Back



Example 1 (as pictured)

- ① White spruce
- ② White spruce/soft white
- ③ White
- ④ White/grey
- ⑤ Classic in Pure White



Example 2 (as pictured)

Front



Back



- ① Natural oak
- ②-LCD Natural oak/black
- ③ Black
- ④ Black/black
- ⑤ Matt in Black

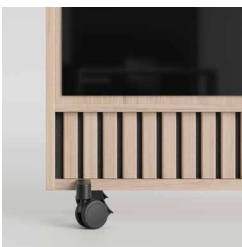

Dynamic Wood Acoustic Shelf

(continues on page 53)

Item no.	Description	Colour	Dimensions	
1				
FRAME		Wood	W x H x D mm	
DYNSHFR-WS	Dynamic Shelf wood frame in white pigmented spruce	white spruce ^A	1290 x 1890 x 120	
DYNSHFR-OAK	Dynamic Shelf wood frame in clear matt lacquered oak	black oak ^B	1290 x 1890 x 120	
DYNSHFR-BO ^{NEW}	Dynamic Shelf wood frame in black matt lacquered oak	natural oak ^C	1290 x 1890 x 120	
2				
SLATS & ACOUSTIC AQSORB PET FELT (FRONT AND BACK)		Wood / AQsorb felt	Front panel	Back panel
			W x H mm	W x H mm
DYNSHAQ-WS	Dynamic wood slats in white pigmented spruce with AQsorb PET felt in soft white	white spruce /soft white ^A	1225 x 176	1225 x 176
DYNSHAQ-OAK	Dynamic wood slats in clear matt lacquered oak with AQsorb PET felt in black	natural oak /black ^B	1225 x 176	1225 x 176
DYNSHAQ-BO ^{NEW}	Dynamic wood slats in black matt lacquered oak with AQsorb PET felt in black	black oak /black ^C	1225 x 176	1225 x 176
3				
FEET			W x H x D mm	
DYNFE-W	Dynamic set of 2 aluminium feet for casters	white ^A	38 x 40 x 420	
DYNFE-B	Dynamic set of 2 aluminium feet for casters	black ^{B/C}	38 x 40 x 420	
4				
CASTERS			Ø mm	
DYNCA-W	Dynamic set of 4 soft brake casters	white/grey ^A	75	
DYNCA-B	Dynamic set of 4 soft brake casters	black/black ^{B/C}	75	
5				
SHELVES & SUPPORTS			W x D x THK mm	
DYNSH-W	Dynamic set of 3 shelves	white ^A	580 x 220 x 4	
DYNSH-B	Dynamic set of 3 shelves	black ^{B/C}	580 x 220 x 4	
DYNSHBRACKET-W	Dynamic set of 6 shelf support brackets	white ^A		
DYNSHBRACKET-B	Dynamic set of 6 shelf support brackets	black ^{B/C}		
6				
BOOKENDS (OPTIONAL)			W x H x THK mm	
DYNSHBE-W	Dynamic set of 3 bookends for shelves	white ^A	140 x 155 x 4	
DYNSHBE-B	Dynamic set of 3 bookends for shelves	black ^{B/C}	140 x 155 x 4	
7				
BOTANIC PLANT BOXES^{NEW} (OPTIONAL ALTERNATIVE TO SHELVES)			W x H x D mm	
DYNSHBOT-W	Dynamic Botanic set of 3 plant boxes	white ^A	580 x 140 x 220	
DYNSHBOT-B	Dynamic Botanic set of 3 plant boxes	black ^{B/C}	580 x 140 x 220	

NB Predefined colour & material combinations:

Go to page 64 for colours & materials

^AWhite spruce + soft white AQsorb felt + white shelves (/plant boxes) + white feet + white/grey casters

^{B/C}Natural/black oak + black AQsorb felt + black shelves (/plant boxes) + black feet + black casters

Other combinations are available upon request, for 25+ units

[return to index](#)

Item no.	Description	Colour	Dimensions	
8 A				
GLASS BOARD - SIDE A			W x H mm	kg
MT60150	Classic magnetic glass board	Pure White	600 x 1500	16.0
MT60150	Classic magnetic glass board	other colours	600 x 1500	16.0
MTM60150	Matt magnetic glass board	Pure White	600 x 1500	16.0
MTM60150	Matt magnetic glass board	other colours	600 x 1500	16.0
8 B				
GLASS BOARD - SIDE B			W x H mm	kg
MT60150	Classic magnetic glass board	Pure White	600 x 1500	16.0
MT60150	Classic magnetic glass board	other colours	600 x 1500	16.0
MTM60150	Matt magnetic glass board	Pure White	600 x 1500	16.0
MTM60150	Matt magnetic glass board	other colours	600 x 1500	16.0
Add accessories with a Basic Kit (only available for purchase with a main CHAT BOARD® product):				
KITBLACK	Basic kit Black	1 Black Marker Pen, 3 Chrome Magnets		
KITWHITE	Basic kit White	1 White Neon Marker Pen, 3 Chrome Magnets		

Go to page 64 for colours & materials

Dynamic Wood Acoustic Shelf

Variants & dimensions

Side A

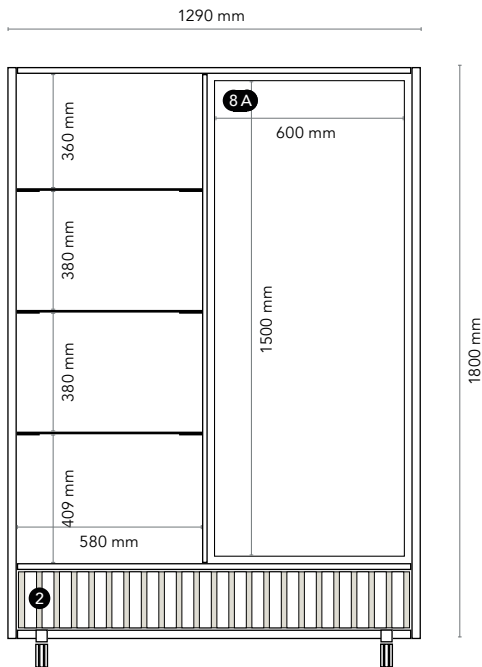

Side B

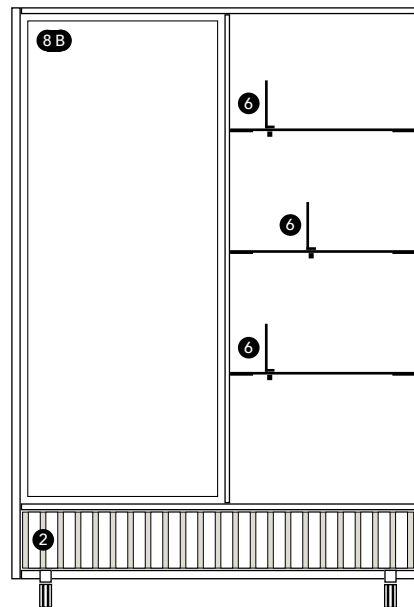

Side

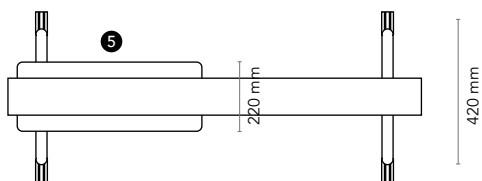
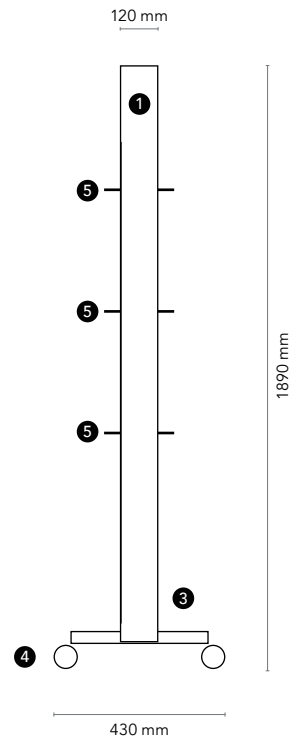

Botanic^{NEW} (optional)

7 shelves are replaced by 3 plant boxes

Side

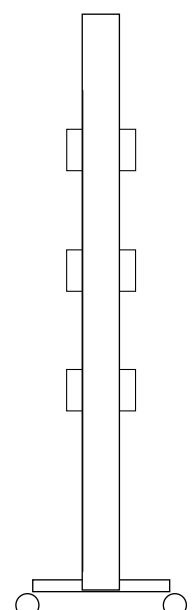
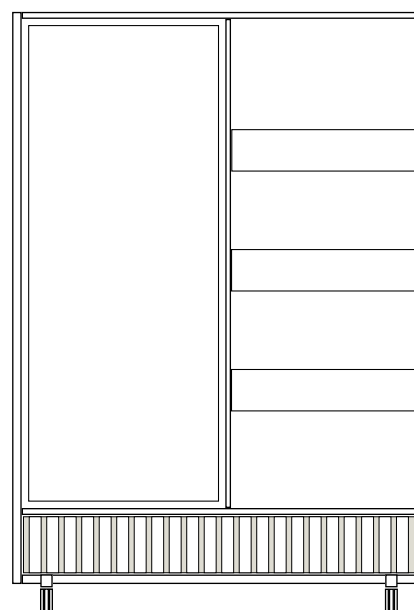

- 1 Wood frame
- 2 Wood slats with AQsorb PET felt with low front and back panels
- 3 Aluminium feet
- 4 Casters
- 5 Shelves and supports
- 6 (Optional) bookends
- 7 (Optional) Botanic plant boxes
- 8A Glass board - side A
- 8B Glass board - side B

[return to index](#)

Dynamic Wood Acoustic Shelf

Suggested combinations

Side A

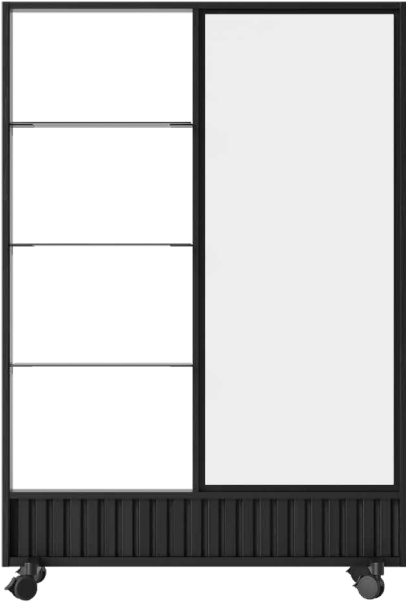

Side B



Example 1 (as pictured)

- ① Black oak
- ② Black oak/black
- ③ Black
- ④ Black/black
- ⑤ Black
- ⑧A Classic in Pure White
- ⑧B Classic in Pure White



Example 2 (as pictured)

- ① White spruce
- ② White spruce/soft white
- ③ White
- ④ White/grey
- ⑦ White
- ⑧A Matt in Ink
- ⑧B Matt in Ink



Side A



Side B



Dynamic Fabric Acoustic

CHAT BOARD® Dynamic Fabric Acoustic is seriously dedicated to sound reduction, integrating class A acoustic panels, beautifully covered in a choice of sexily sustainable fabrics, thus creating the perfect balance between surface textures.

Dynamic Fabric Acoustic comes in two variants, Full Coverage and Shelf, each offering a broad selection of combinations across materials, colours, and optional add-ons. The Full Coverage variant delivers full-scale, mobile room dividing performance with a built-in writable glass board on one side, and high-performance acoustic panels on the other.

The Shelf variant ingeniously combines the agile flexibility of a movable partition wall with a useful shelving system to provide equal parts storage and writing surface in a design where one side mirrors the other for double-sided benefit. As a new addition to the collection, the Shelf frame can be fitted with three plant boxes; the perfect way to bring a touch of nature into the workspace.

The Dynamic Fabric Acoustic frames are manufactured from solid wood (spruce or oak), finished with a matt PU lacquer.

The 40 mm acoustic panels are composed of stone wool and covered in a fabric that matches your preferences and desired price category: Quest^{cat1} and Sumi^{cat2} by Camira, Molly^{cat3} and Clara^{cat3} by Kvadrat.

Aluminium parts (feet, shelves, shelf supports and bookends) are powder coated in Signal White (RAL 9003) or Jet Black (RAL 9005).

The Dynamic Fabric Acoustic units are made easily mobile by the Ø75 mm soft brake casters, matched to your choice of wood frame: white/grey with white spruce, and black/black with natural oak and black oak.

The integrated glass boards are made with 4 mm tempered safety glass, in accordance with the highest quality standards, finished with smooth C-edges and 4 mm radius corners. Choose between a glossy Classic and a velvety Matt finish as well as a palette of 25 standard glass colours. In addition, the glass can also be made to order in bespoke standard RAL or NCS colours, available for glass.

Please contact our head office with any special requests: info@chat-board.dk



Dynamic Fabric Acoustic Full Coverage

Item no.	Description	Colour	Dimensions	
1				
FRAME		Wood	W x H x D mm	
DYNFCFR-WS	Dynamic Full Coverage wood frame in white pigmented spruce	white spruce ^A	1290 x 1890 x 120	
DYNFCFR-OAK	Dynamic Full Coverage wood frame in clear matt lacquered oak	natural oak ^B	1290 x 1890 x 120	
DYNFCFR-BO ^{NEW}	Dynamic Full Coverage wood frame in black matt lacquered oak	black oak ^C	1290 x 1890 x 120	
2				
ACOUSTIC PANELS (FRONT AND BACK)		Fabric	Front panel W x H x THK mm	Back panel (x2) W x H x THK mm
DYNFCACU1	Dynamic class A acoustic panels covered in fabric from price category 1	Quest by Camira	1225 x 176 x 40	612.5 x 1738 x 40
DYNFCACU2	Dynamic class A acoustic panels covered in fabric from price category 2	Sumi by Camira	1225 x 176 x 40	612.5 x 1738 x 40
DYNFCACU3	Dynamic class A acoustic panels covered in fabric from price category 3	Molly / Clara by Kvadrat	1225 x 176 x 40	612.5 x 1738 x 40
3				
FEET			W x H x D mm	
DYNFE-W	Dynamic set of 2 aluminium feet for casters	white ^A	38 x 40 x 420	
DYNFE-B	Dynamic set of 2 aluminium feet for casters	black ^{B/C}	38 x 40 x 420	
4				
CASTERS			Ø mm	
DYNCA-W	Dynamic set of 4 soft brake casters	white/grey ^A	75	
DYNCA-B	Dynamic set of 4 soft brake casters	black/black ^{B/C}	75	
5				
GLASS BOARD			W x H mm	kg
MT120150	Classic magnetic glass board	Pure White	1200 x 1500	31.0
MT120150	Classic magnetic glass board	other colours	1200 x 1500	31.0
MTM120150	Matt magnetic glass board	Pure White	1200 x 1500	31.0
MTM120150	Matt magnetic glass board	other colours	1200 x 1500	31.0
Add accessories with a Basic Kit (only available for purchase with a main CHAT BOARD® product):				
KITBLACK	Basic kit Black	1 Black Marker Pen, 3 Chrome Magnets		
KITWHITE	Basic kit White	1 White Neon Marker Pen, 3 Chrome Magnets		

NB Predefined colour & material combinations:

^AWhite spruce + white feet + white/grey casters

^{B/C}Natural/black oak + black feet + black casters

Other combinations are available upon request, for 25+ units

[return to index](#)

Go to page 64 for colours & materials

Dynamic Fabric Acoustic Full Coverage

Variants & dimensions

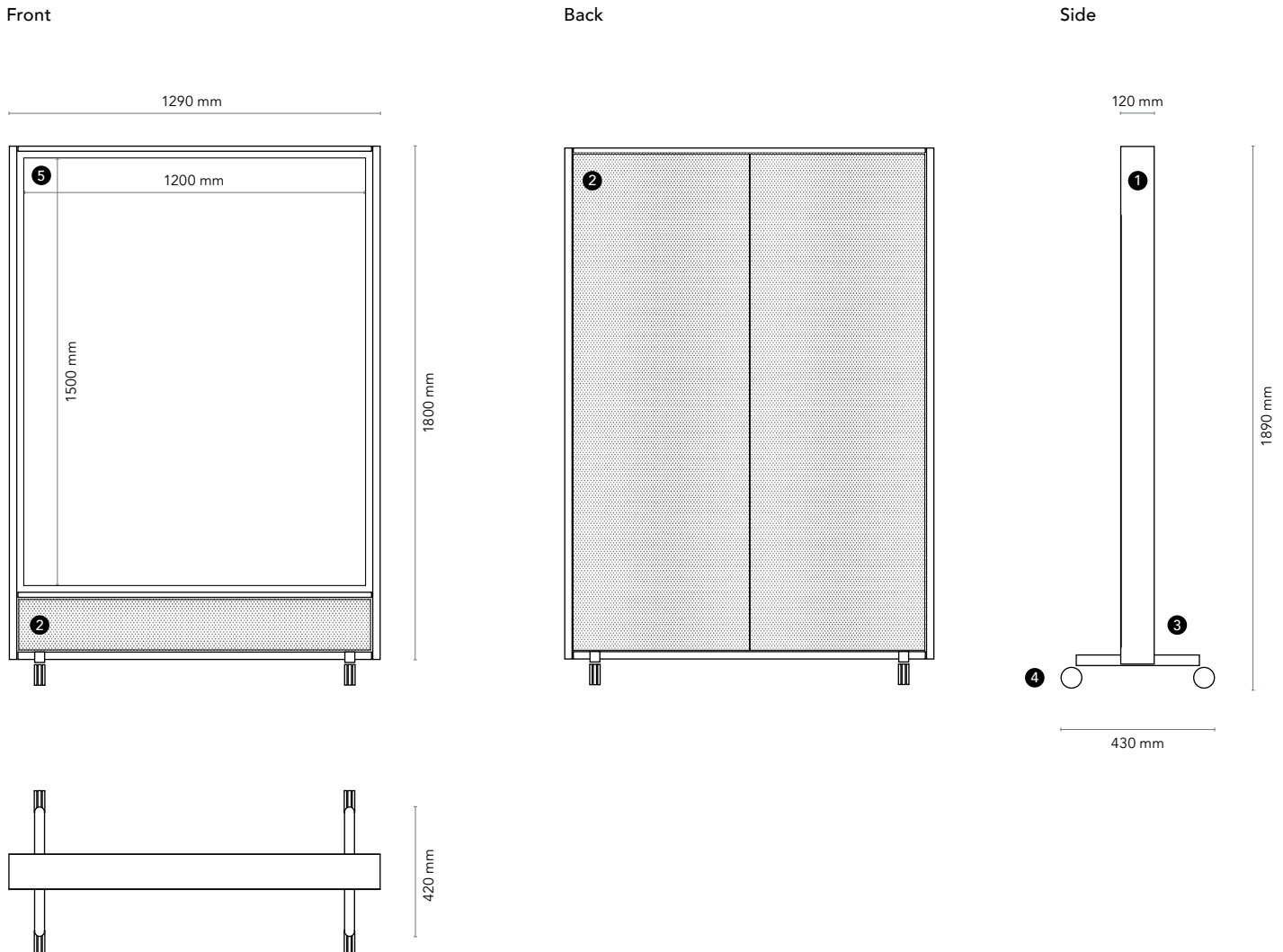

- ① Wood frame
- ② Fabric covered class A acoustic panels
- ③ Aluminium feet
- ④ Casters
- ⑤ Glass board

Dynamic Fabric Acoustic Full Coverage

Suggested combinations

Front



Back



Example 1 (as pictured)

- ① White spruce
- ② Quest 03 Barnacle
- ③ White
- ④ White/grey
- ⑤ Classic in Sand



Example 2 (as pictured)

- ① Natural oak
- ② Sumi 3 Kobe
- ③ Black
- ④ Black/black
- ⑤ Classic in Black



Front



Back

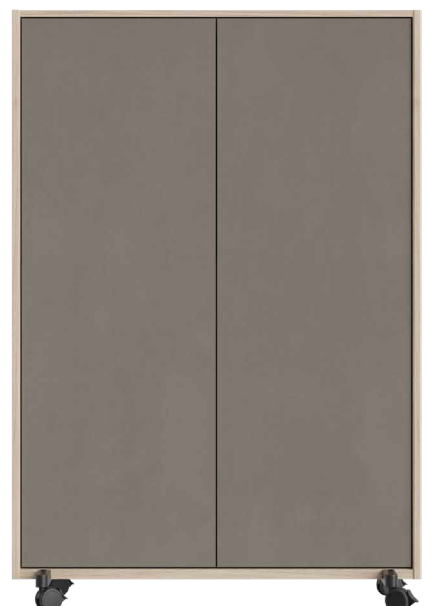

Dynamic Fabric Acoustic Shelf

(continues on page 61)

Item no.	Description	Colour	Dimensions	
1				
FRAME		Wood	W x H x D mm	
DYNSHFR-WS	Dynamic Shelf wood frame in white pigmented spruce	white spruce ^A	1290 x 1890 x 120	
DYNSHFR-OAK	Dynamic Shelf wood frame in clear matt lacquered oak	natural oak ^B	1290 x 1890 x 120	
DYNSHFR-BO ^{NEW}	Dynamic Shelf wood frame in black matt lacquered oak	black oak ^C	1290 x 1890 x 120	
2			Front panel	Back panel
ACOUSTIC PANELS (FRONT AND BACK)		Fabric	W x H x THK mm	W x H x THK mm
DYNSHACU1	Dynamic class A acoustic panels covered in fabric from price category 1	Quest by Camira	1225 x 176 x 40	1225 x 176 x 40
DYNSHACU2	Dynamic class A acoustic panels covered in fabric from price category 2	Sumi by Camira	1225 x 176 x 40	1225 x 176 x 40
DYNSHACU3	Dynamic class A acoustic panels covered in fabric from price category 3	Molly / Clara by Kvadrat	1225 x 176 x 40	1225 x 176 x 40
3			W x H x D mm	
FEET				
DYNFE-W	Dynamic set of 2 aluminium feet for casters	white ^A	38 x 40 x 420	
DYNFE-B	Dynamic set of 2 aluminium feet for casters	black ^{B/C}	38 x 40 x 420	
4			Ø mm	
CASTERS				
DYNCA-W	Dynamic set of 4 soft brake casters	white/grey ^A	75	
DYNCA-B	Dynamic set of 4 soft brake casters	black/black ^{B/C}	75	
5			W x D x THK mm	
SHELVES & SUPPORTS				
DYNSH-W	Dynamic set of 3 shelves	white ^A	580 x 220 x 4	
DYNSH-B	Dynamic set of 3 shelves	black ^{B/C}	580 x 220 x 4	
DYNSHBRACKET-W	Dynamic set of 6 shelf support brackets	white ^A		
DYNSHBRACKET-B	Dynamic set of 6 shelf support brackets	black ^{B/C}		
6			W x H x THK mm	
BOOKENDS (OPTIONAL)				
DYNSHBE-W	Dynamic set of 3 bookends for shelves	white ^A	140 x 155 x 4	
DYNSHBE-B	Dynamic set of 3 bookends for shelves	black ^{B/C}	140 x 155 x 4	
7			W x H x D mm	
BOTANIC PLANT BOXES^{NEW} (OPTIONAL ALTERNATIVE TO SHELVES)				
DYNSHBOT-W	Dynamic Botanic set of 3 plant boxes	white ^A	580 x 140 x 220	
DYNSHBOT-B	Dynamic Botanic set of 3 plant boxes	black ^{B/C}	580 x 140 x 220	

NB Predefined colour & material combinations:

Go to page 64 for colours & materials

^AWhite spruce + white shelves (/plant boxes) + white feet + white/grey casters

^{B/C}Natural/black oak + black shelves (/plant boxes) + black feet + black casters

Other combinations are available upon request, for 25+ units

[return to index](#)

Item no.	Description	Colour	Dimensions	
8 A				
GLASS BOARD - SIDE A			W x H mm	kg
MT60150	Classic magnetic glass board	Pure White	600 x 1500	16.0
MT60150	Classic magnetic glass board	other colours	600 x 1500	16.0
MTM60150	Matt magnetic glass board	Pure White	600 x 1500	16.0
MTM60150	Matt magnetic glass board	other colours	600 x 1500	16.0
8 B				
GLASS BOARD - SIDE B			W x H mm	kg
MT60150	Classic magnetic glass board	Pure White	600 x 1500	16.0
MT60150	Classic magnetic glass board	other colours	600 x 1500	16.0
MTM60150	Matt magnetic glass board	Pure White	600 x 1500	16.0
MTM60150	Matt magnetic glass board	other colours	600 x 1500	16.0
Add accessories with a Basic Kit (only available for purchase with a main CHAT BOARD® product):				
KITBLACK	Basic kit Black	1 Black Marker Pen, 3 Chrome Magnets		
KITWHITE	Basic kit White	1 White Neon Marker Pen, 3 Chrome Magnets		

Go to page 64 for colours & materials

Dynamic Fabric Acoustic Shelf

Variants & dimensions

Side A

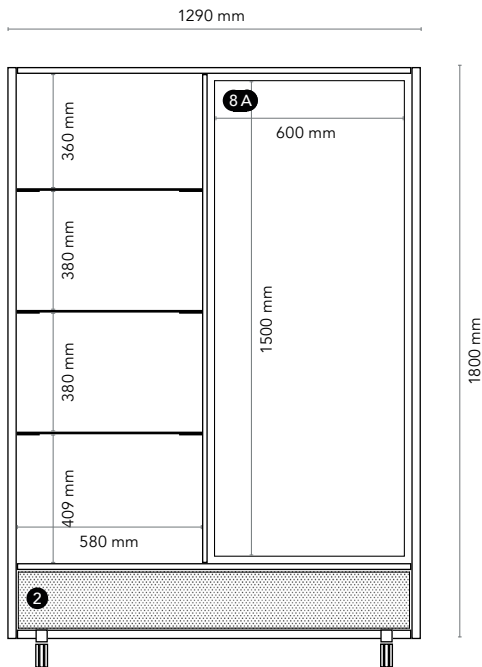

Side B

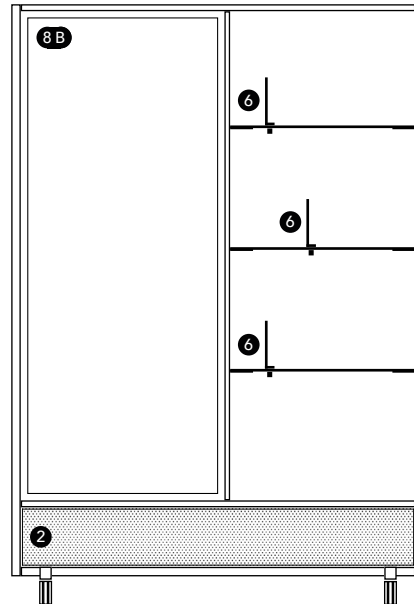

Side

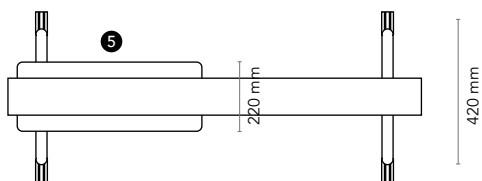
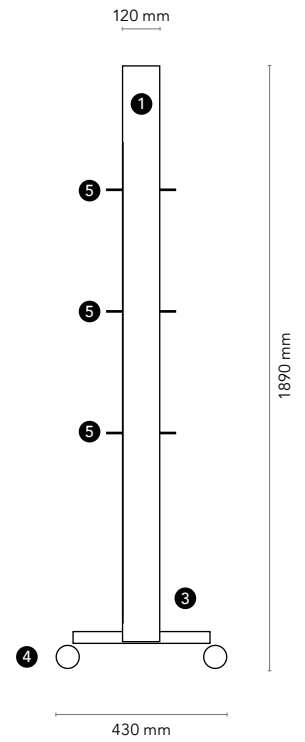

Botanic^{NEW} (optional)

7 shelves are replaced by 3 plant boxes

Side

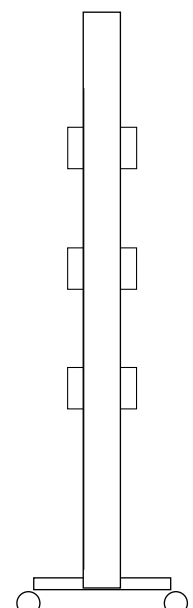
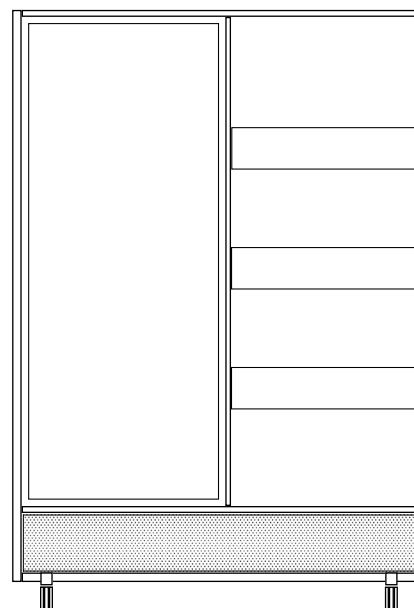

- 1 Wood frame
- 2 Fabric covered class A acoustic panels
- 3 Aluminium feet
- 4 Casters
- 5 Shelves and supports
- 6 (Optional) bookends
- 7 (Optional) Botanic plant boxes
- 8A Glass board - side A
- 8B Glass board - side B

[return to index](#)

Dynamic Fabric Acoustic Shelf

Suggested combinations

Side A

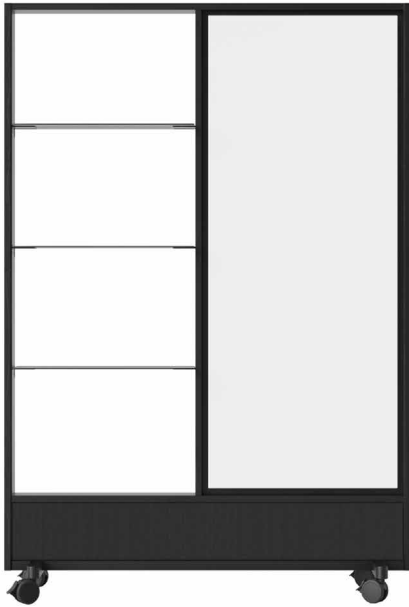

Side B

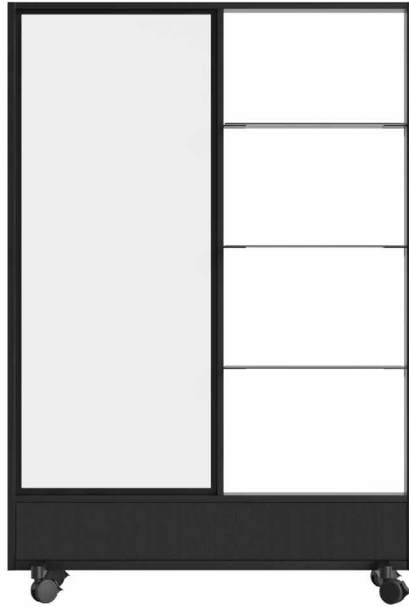

Example 1 (as pictured)

- ① Black oak
- ② Clara 0188
- ③ Black
- ④ Black/black
- ⑤ Black
- ⑧A Matt in Pure White
- ⑧B Matt in Pure White



Example 2 (as pictured)

- ① White spruce
- ② Quest 03 Barnacle
- ③ White
- ④ White/grey
- ⑦ White
- ⑧A Classic in Stone
- ⑧B Classic in Stone



Side A



Side B



Dynamic

Colours & materials

Glass

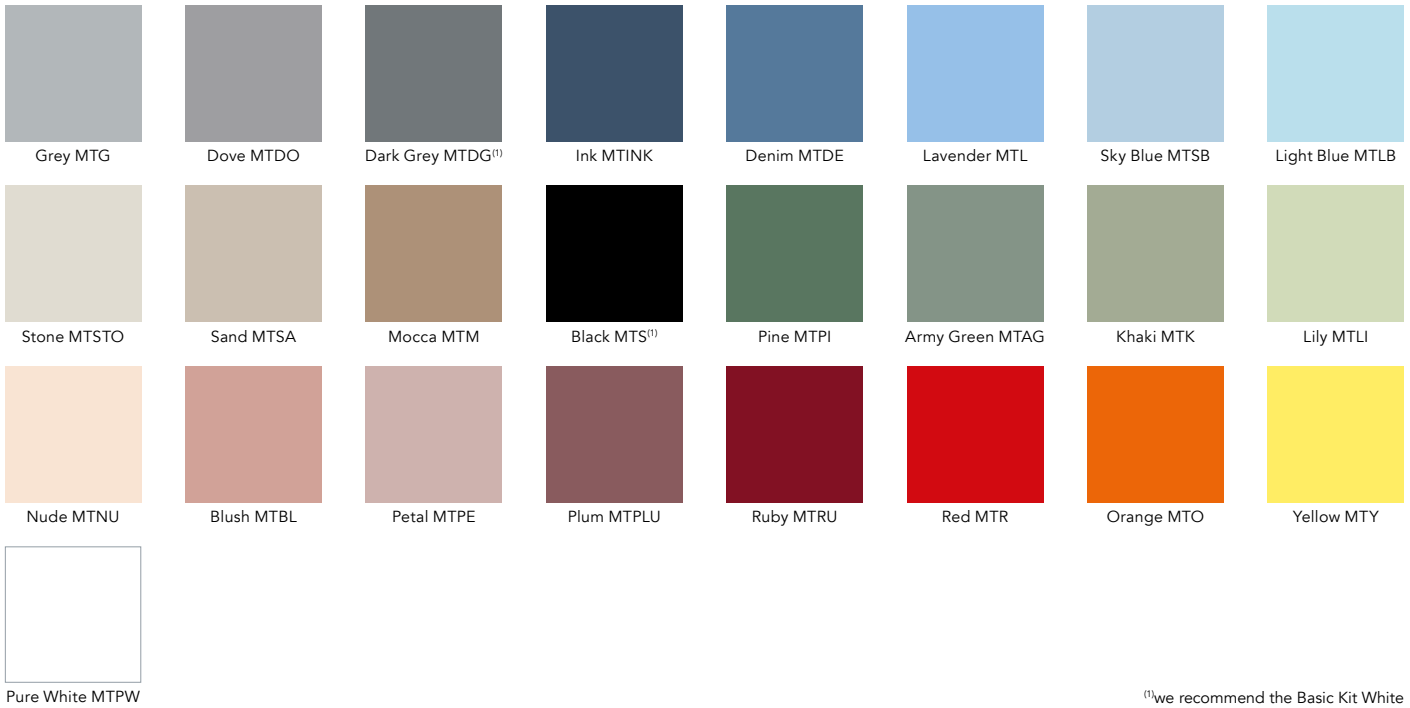

⁽¹⁾We recommend the Basic Kit White

Wood

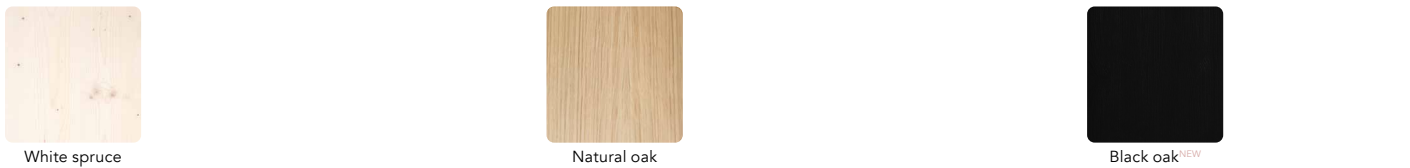

Predefined colour combinations: wood, AQsorb felt (for Wood Acoustic), feet, casters and shelves/plant boxes* (where applicable)



Fabric



Category 1

Quest by Camira
100% post-consumer recycled polyester
incl. 75% SEAQUAL yarn

Category 2

Sumi by Camira
90% wool, 10% polyamide

Category 3

Molly by Kvadrat
100% new wool worsted
Clara by Kvadrat
92% new wool worsted, 8% nylon

AQsorb PET felt



Aluminium (*galvanized steel)





Wardrobe

CHAT BOARD® Wardrobe cleverly merges a functional and spacious wardrobe unit with a large, magnetic glass board. Continuing the clear, intentionally understated design aesthetics of the entire CHAT BOARD® collection, the signature glass board is here transformed into a stationary piece of furniture, lending a new dimension to its core purpose. Placed in a reception area, entrance hall or lobby, the Wardrobe is the perfect way to greet visitors or co-workers with a message of welcome, an illustration or any kind of useful information. At home it will soon become an indispensable part of daily life, as a practical storage space and an unmissable place for sharing last-minute messages, shopping lists and notes of future appointments.

CHAT BOARD® Wardrobe is made with 4 mm tempered safety glass, in accordance with the highest quality standards, finished with smooth C-edges and 4 mm radius corners. It is available in 2 sizes and 25 standard glass colours, as well as in a mirror finish. In addition, it can be made to order in bespoke standard RAL or NCS glass colours.

Please contact our head office with any special requests: info@chat-board.dk



Wardrobe

Item no.	Description	Dimensions		Weight kg
		Glass W x H mm	Total size W x H x D mm	
CBWA60	Wardrobe wall-mounted wardrobe unit with a magnetic glass front	600 x 2000	600 x 2100 x 410	45.0
CBWA120	Wardrobe wall-mounted wardrobe unit with a magnetic glass front	1200 x 2000	1200 x 2100 x 4100	80.0

Add accessories with a Basic Kit
(only available for purchase with a main CHAT BOARD® product):

KITBLACK	Basic kit Black	1 Black Marker Pen, 3 Chrome Magnets
KITWHITE	Basic kit White	1 White Neon Marker Pen, 3 Chrome Magnets

Optional add Matt glass to Wardrobe

Glass

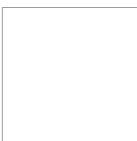
							
Grey MTG	Dove MTDO	Dark Grey MTDG ⁽¹⁾	Ink MTINK	Denim MTDE	Lavender MTL	Sky Blue MTSB	Light Blue MTLB
							
Stone MTSTO	Sand MTSA	Mocca MTM	Black MTS ⁽¹⁾	Pine MTP	Army Green MTAG	Khaki MTK	Lily MTL
							
Nude MTNU	Blush MTBL	Petal MTPE	Plum MTPLU	Ruby MTRU	Red MTR	Orange MTO	Yellow MTY
							
Pure White MTPW	Mirror MTMIR						

⁽¹⁾we recommend the Basic Kit White

Wardrobe

Variants & dimensions

Wardrobe 60 cm

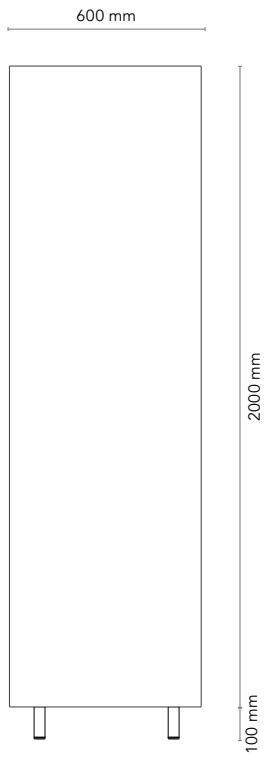

Wardrobe 120 cm

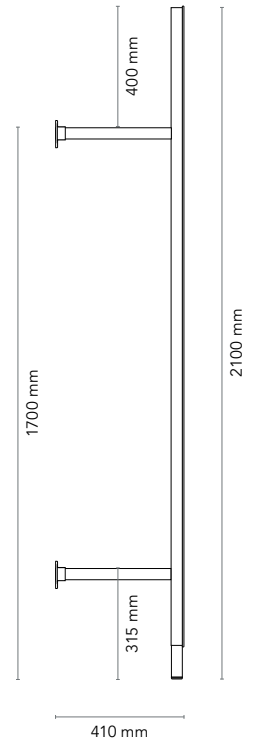
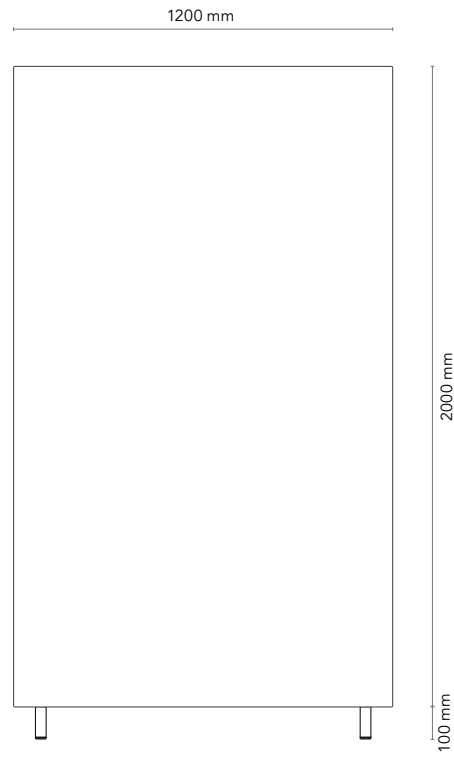

ACCESSORIES

functional finishing touches

DISCØ NEW

The new CHAT BOARD® DISCØ [di-skow] collection is a fresh and slightly flirtatious take on the quintessential glass board accessories. Sculpted for the human hand, the reassuring warmth of the softly shaped wooden discs puts the pleasure back into erasing and adhering, all with a playful twist.

The conveniently magnetic DISCØ eraser effortlessly carries a CHAT BOARD® marker in its embrace and comes with an elegant entourage of five accompanying DISCØ magnets, mirroring the same, understated, yet undeniably cool design.

Get carried away by the new DISCØ fever and let those groovy moves slide over your CHAT BOARD® product of choice without regret.

DISCØ is crafted from solid oak, and it is available in natural and black, both with a touchable matt lacquered finish.

We recommend getting perfectly warmed up with the essential DISCØ set of 1 eraser and 5 magnets.

Both are also available for purchase individually, and the magnets in sets of 10 pieces.



Item no.	Description		Dimensions
Natural oak			Ø x D mm
DISCØSET-O	DISCØ Set in oak - clear lacquered	1 Eraser ^A , 5 Magnets, 1 Black Marker Pen	
DISCØERS-O	DISCØ Eraser in oak - clear lacquered	1 Eraser ^A	80 x 24
DISCØMAG-O	DISCØ Magnet in oak - clear lacquered	1 Magnet	19 x 24
DISCØMAG10-O	DISCØ Magnet Set in oak - clear lacquered	10 Magnets	
Black oak			Ø x D mm
DISCØSET-B	DISCØ Set in oak - black lacquered	1 Eraser ^A , 5 Magnets, 1 Black Marker Pen	
DISCØERS-B	DISCØ Eraser in oak - black lacquered	1 Eraser ^A	80 x 24
DISCØMAG-B	DISCØ Magnet in oak - black lacquered	1 Magnet	19 x 24
DISCØMAG10-B	DISCØ Magnet Set in oak - black lacquered	10 Magnets	

^A2 extra felt eraser pads are included

Wood



Oak - clear lacquered



Oak - black lacquered

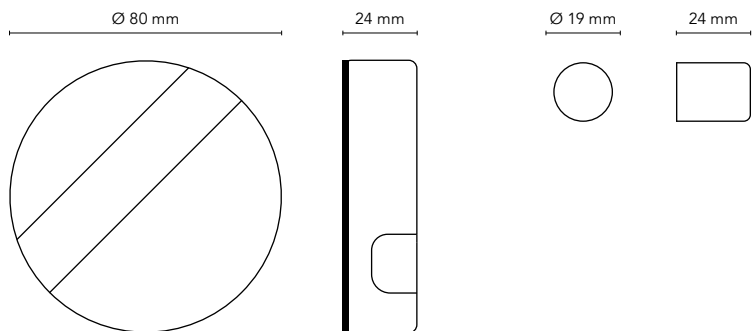

Classic Crafted Keeper

Complete your CHAT BOARD® product with the Classic Crafted Keeper, a magnetic pen holder exquisitely shaped in wood veneer. Fully flexible and easily attached and detached, it can be placed on any magnetic CHAT BOARD® surface and moved around according to mood and circumstances.

The CHAT BOARD® Classic Crafted Keeper is crafted from oak or ash veneer, treated with a PU clear coat or black lacquer (clear on oak, and black on ash).



Classic Crafted Keeper

Item no.	Description	Dimensions	Weight
Oak veneer		W x H x D mm	kg
MTCROKE	Classic Crafted Keeper magnetic pen holder in natural, lacquered oak veneer	100 x 100 x 70	0.3
Black ash veneer ^{NEW}		W x H x D mm	kg
MTCRBKE	Classic Crafted Keeper magnetic pen holder in black, lacquered ash veneer	100 x 100 x 70	0.3

Wood veneer



Oak
natural, lacquered



Ash^{NEW}
black, lacquered

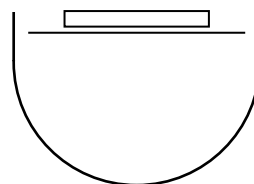
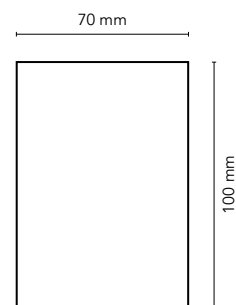
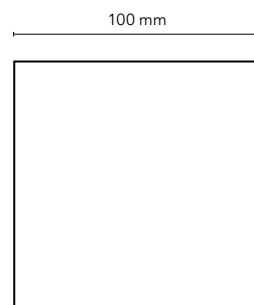

Storage Unit

CHAT BOARD® Storage Unit, in a timeless and sleek design by ARDE design studio, is a functional two-compartment storage unit for all of your CHAT BOARD® accessories. Available in 2 different versions, one to perfectly complement any of our boards, it offers the perfect solution for organising and keeping track of pens, erasers and extra magnets.

CHAT BOARD® Storage Unit is made of injection moulded ABS and powder coated steel, making it durable as well as functional.

It is available in 2 different versions, and in a choice of 2 versatile colours: Signal White (RAL 9003) and Jet Black (RAL 9005).



Storage Unit

Item no.	Description	Dimensions	Weight
		W x H x D mm	kg
White			
SUMAG9003	Storage Unit Magnetic magnetic pen holder - white	205 x 120 x 95	0.5
SUHAN9003	Storage Unit Hanger pen holder with board-/wall picture - white	205 x 125 x 100	0.5
Black			
SUMAG9005	Storage Unit Magnetic magnetic pen holder - black	205 x 120 x 95	0.5
SUHAN9005	Storage Unit Hanger pen holder with board-/wall picture - black	205 x 125 x 100	0.5

ABS & steel



Magnetic

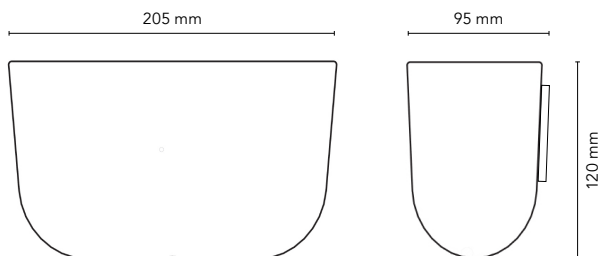

Hanger

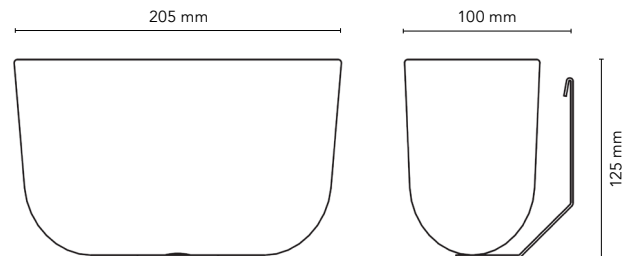

Essential Accessories

We offer a broad selection of sleek and functional accessories, designed to be used across the entire CHAT BOARD® collection while providing the best possible user-experience and making the most of each of our products.

All of our pens have been specially developed for use on glass, ensuring that writing and illustrations are clearly visible on the smooth surface. Regardless of whether you opt for the dry erase markers, which work best on boards in lighter colours, or our neon pens, which stand out against even the darkest background.

The CHAT BOARD® magnets are extra strong and specially developed to adhere through glass, while still being able to hold up to 15 sheets of A4 paper.

NB We recommend that you always use CHAT BOARD® pens and magnets with our products.

Make the most of your CHAT BOARD® product with one of our Starter Sets, each providing everything needed to get off to the best possible start. And with 12 different combinations available, each with a unique selection of pens, magnets and erasers, there is every opportunity to find the perfect pairing for your specific needs.

There are two types of Pen Trays in the CHAT BOARD® accessories collection; the acrylic pen trays are available in both clear and white opaque and come in two different sizes, while the powder-coated aluminium pen trays are available in a further 7 sizes, each matching a standard CHAT BOARD® width. For easy mounting (and removal) each of our Pen Trays is fitted with a strong adhesive strip, which fixes onto the steel frame on the back of the board.











Pens, magnets, cleaners etc.

Item no.	Description		Weight
			kg
CB517BLACK	Black dry erase marker pen 1 pc		0.020
CB517SET4	Dry erase marker pen set - Standard 4 pcs: black / red / blue / green		0.080
CB517SET4MATT	Dry erase marker pen set - Matt 4 pcs: black / black / blue / green		0.080
CBNEONW01	White neon marker pen 1 pc		0.020
CBNEON041	Neon marker pen set I 4 pcs: blue / green / yellow / white		0.080
CBNEON042	Neon marker pen set II 4 pcs: pink / purple / orange / white		0.080
MAG161210	Chrome magnet 10 pcs		0.160
MTERS	Eraser magnetic cleaning sponge		0.020
CBOWMAG	Woody Magnet with wooden cover in natural oiled ash 1 pc		0.021
CBOWMAG10	Woody Magnet with wooden cover in natural oiled ash 10 pcs		0.210
CBBWMAG	Woody Magnet with wooden cover in black stained ash 1 pc		0.021
CBBWMAG10	Woody Magnet with wooden cover in black stained ash 10 pcs		0.210
CBOWERS	Woody Eraser in natural oiled ash incl. 2 extra felt eraser pads		0.205
CBBWERS	Woody Eraser in black stained ash incl. 2 extra felt eraser pads		0.205
CBFIBRE	Woody felt eraser pads (extra) 5 pcs		0.020
CBCLEANER	Cleaner glass cleaning liquid 110 ml bottle		0.120
CBMICROFIBERSET	Microfibre cleaning cloths 5 pcs		0.200

[return to index](#)

Starter sets

(continues on page 79)

Item no.	Description	Weight
Basic starter sets		kg
CBSTARTSET	Starter Set - Standard incl. 1 Eraser, 1 Cleaner, 5 chrome magnets, 4 dry erase marker pens: black / red / blue / green	0.350
		
CBSTARTSET MATT	Starter Set - Matt incl. 1 Eraser, 1 Cleaner, 5 chrome magnets, 4 dry erase marker pens: black / black / blue / green	0.350
		
CBSTARTSET01	Starter Set - Neon I incl. 1 Eraser, 1 Cleaner, 5 chrome magnets, 4 neon marker pens: blue / green / yellow / white	0.350
		
CBSTARTSET02	Starter Set - Neon II incl. 1 Eraser, 1 Cleaner, 5 chrome magnets, 4 neon marker pens: pink / purple / orange / white	0.350
		
Woody starter sets - natural oiled ash		kg
CBSARTSETOW517	Woody Starter Set Natural - Standard incl. 1 Woody Eraser, 1 Cleaner, 5 Woody Magnets, 4 dry erase marker pens: black / red / blue / green	0.560
		
CBSTARTSETOW517 MATT	Woody Starter Set Natural - Matt incl. 1 Woody Eraser, 1 Cleaner, 5 Woody Magnets, 4 dry erase marker pens: black / black / blue / green	0.560
		
CBSTARTSETOW01	Woody Starter Set Natural - Neon I incl. 1 Woody Eraser, 1 Cleaner, 5 Woody Magnets, 4 neon marker pens: blue / green / yellow / white	0.560
		
CBSTARTSETOW02	Woody Starter Set Natural - Neon II incl. 1 Woody Eraser, 1 Cleaner, 5 Woody Magnets, 4 neon marker pens: pink / purple / orange / white	0.560
		

[return to index](#)

Starter sets

(continued from page 78)





Item no.	Description	Weight
Woody starter sets - black stained ash		
CBSTARTSETBW517	Woody Starter Set Black - Standard incl. 1 Woody Eraser, 1 Cleaner, 5 Woody Magnets, 4 dry erase marker pens: black / red / blue / green	0.560
CBSTARTSETBW517 MATT	Woody Starter Set Black I - Matt incl. 1 Woody Eraser, 1 Cleaner, 5 Woody Magnets, 4 dry erase marker pens: black / black / blue / green	0.560
CBSTARTSETBW01	Woody Starter Set Black - Neon I incl. 1 Woody Eraser, 1 Cleaner, 5 Woody Magnets, 4 neon marker pens: blue / green / yellow / white	0.560
CBSTARTSETBW02	Woody Starter Set Black - Neon II incl. 1 Woody Eraser, 1 Cleaner, 5 Woody Magnets, 4 neon marker pens: pink / purple / orange / white	0.560

Pen trays

Item no.	Description	Weight
Acrylic		
		kg
BP15W	Pen tray 15 - white acrylic L 150 mm	0.030
		
PB15	Pen tray 15 - clear acrylic L 150 mm	0.030
		
BP30W	Pen tray 30 - white acrylic L 300 mm	0.060
		
PB30	Pen tray 30 - clear acrylic L 300 mm	0.060
		
Powder coated aluminium (Signal White RAL 9003)		
		kg
PB690	Pen tray 69 - powder coated aluminium L 690 mm matches wall-mounted boards: 69.5 x 69.5 cm, 70 x 90 cm (vertical)	0.280
		
PB890	Pen tray 89 - powder coated aluminium L 890 mm matches wall-mounted boards: 70 x 90 cm (horizontal), 90 x 120 cm (vertical)	0.360
		
PB990	Pen tray 99 - powder coated aluminium L 990 mm matches wall-mounted boards: 100 x 100 cm, 100 x 150 cm (vertical), 100 x 200 cm (vertical)	0.410
		
PB1190	Pen tray 119 - powder coated aluminium L 1190 mm matches wall-mounted boards: 90 x 120 cm (horizontal), 120 x 120 cm, 120 x 150 cm (vertical), 120 x 200 cm (vertical), 120 x 240 cm (vertical)	0.490
		
PB1490	Pen tray 149 - powder coated aluminium L 1490 mm matches wall-mounted boards: 100 x 150 cm (horizontal), 120 x 150 cm (horizontal)	0.610
		
PB1990	Pen tray 199 - powder coated aluminium L 1990 mm matches wall-mounted boards: 100 x 200 cm (horizontal), 120 x 200 cm (horizontal)	0.820
		
PB239	Pen tray 239 - powder coated aluminium L 2390 mm matches wall-mounted board: 120 x 240 cm (horizontal)	0.980
		

[return to index](#)

Miscellaneous accessories & spare parts

Item no.	Description	Weight
Miscellaneous accessories		
FCHANGER	Flip chart holder in powder coated steel Signal White RAL 9003	1.300 kg
		
CBTVBR	TV bracket for mounting on the back of Mobile Conference	3.000
		
Spare parts (extra)		
MAGROUND - SMALL	Mounting Magnet Set - small 2 mounting magnets, incl. washers	for wall-mounted boards, sizes (cm): 40 x 50 to 69.5 x 69.5
		
MAGROUND - BIG	Mounting Magnet Set - big 2 mounting magnets, incl. washers	for wall-mounted boards, sizes (cm): 70 x 90 to 120 x 240
		
METALTRACK4050	Hanging rail L 350 mm	for wall-mounted boards, sizes (cm): 40 x 50
METALTRACK5080	Hanging rail L 450 mm	for wall-mounted boards, sizes (cm): 50 x 80, 58.5 x 120*, 60 x 150* (*vertically mounted)
METALTRACK7090	Hanging rail L 650 mm	for wall-mounted boards, sizes (cm): 69.5 x 69.5, 70 x 90
METALTRACK100100	Hanging rail L 850 mm	for wall-mounted boards, sizes (cm): 90 x 120, 58.5 x 120, 100 x 100, 100 x 120, 120 x 120, 100 x 150*, 120 x 150*, 100 x 200*, 120 x 200* (*vertically mounted)
METALTRACK120120	Hanging rail L 1100 mm NB when ordered separately (and shipped with a courier service), this will be split into smaller lengths	for wall-mounted boards, size (cm): 100 x 150, 120 x 150, 120 x 200*, 120 x 240*, 122 x 244* (*vertically mounted)
METALTRACK120200	Hanging rail L 1900 mm NB when ordered separately (and shipped with a courier service), this will be split into smaller lengths	for wall-mounted boards, sizes (cm): 100 x 200, 120 x 200, 120 x 240, 122 x 244

[return to index](#)

USEFUL INFORMATION

Maintenance

Your CHAT BOARD® product requires minimal daily maintenance and by following these simple guidelines, it will look beautiful for years to come:

Glass

As a rule, we recommend cleaning the board using a CHAT BOARD® Eraser or a soft cloth, depending on how much writing/illustration needs to be removed.

Next, polish the glass with the CHAT BOARD® Cleaner, a window cleaning spray or regular rubbing alcohol.

NB

Never spray Cleaner directly on the writing/illustration as this will prolong the cleaning process, and make sure you always use a soft material such as paper towel - or our favourite: a microfibre cloth.

In case someone has accidentally used permanent marker on the glass, this can be removed with rubbing alcohol, after which the board will be ready to use as normal.

Kvadrat fabrics

Remix Screen, Relate Screen, Molly, Clara:

Vacuum regularly. Professional dry cleaning with tetrachloroethylene, normal process.

Camira fabrics

Quest:

Vacuum regularly. Wipe with a damp cloth using a proprietary upholstery shampoo/soap. For deeper cleaning use steam, bleach, alcohol or professionally dry clean.

Sumi:

Vacuum regularly. Wipe with a damp cloth using soap and water or use proprietary upholstery shampoo. For deeper cleaning use steam or professionally dry clean.

BuzziFelt

Vacuum clean regularly. Do not wash. Do not remove the BuzziFelt from the product. Treat spillages immediately. Professional dry clean or wipe clean with a pH neutral soap and a damp cloth.





designed & manufactured by
CHAT BOARD A/S

Tempovej 10 C
DK-2750 Ballerup
Denmark

+45 4484 5144
info@chat-board.dk
www.chat-board.dk

VAT no. DK 15806230

